

Radio Engineering

APRIL, 1937

VOE 2XVII

NO. 4

DESIGN • PRODUCTION • ENGINEERING

- Broadcast Receivers
- Auto-Radio Receivers
- Electric Photographs
- Sound Recorders
- Sound Projectors
- Audio Amplifiers
- P-A Equipment
- Electronic Control Devices
- Testing and Measuring Equipment
- Television Apparatus
- Loudspeakers
- Components
- Tubes
- Photocells

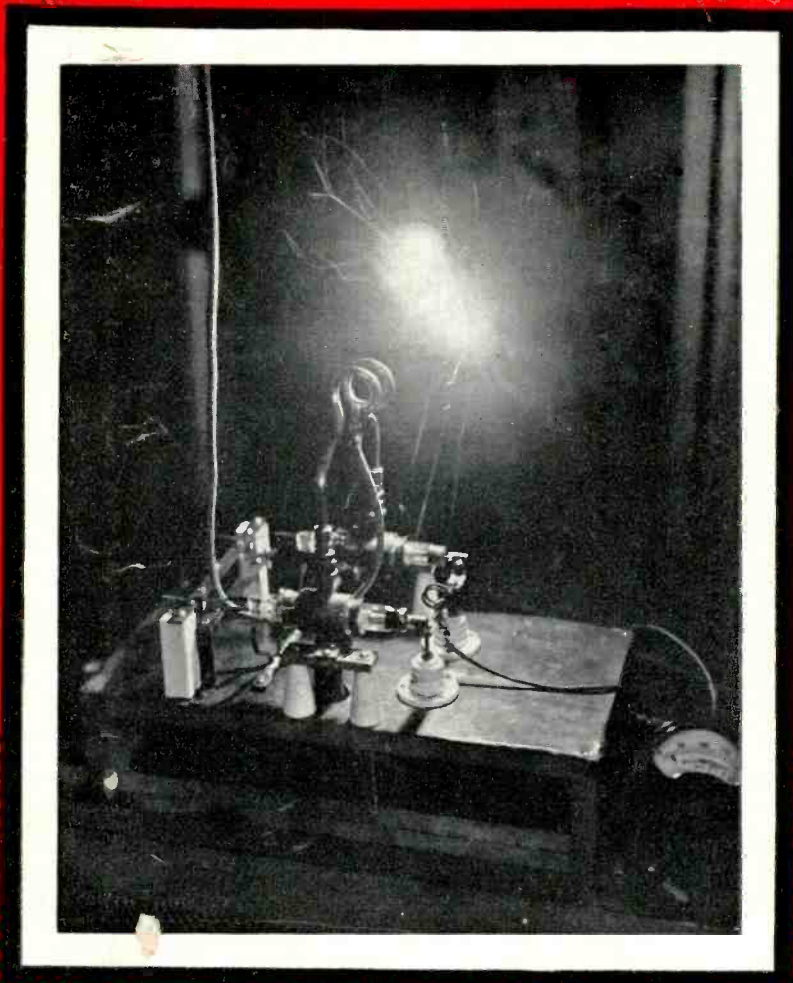

ATTENTION OF:

Pres. _____	V. Pres. _____
Gen. Mgr. _____	Adv. Mgr. _____
Eng. Dept. _____	Prod. Mgr. _____
Sales Mgr. _____	Pur. Agt. _____

The Journal of the
Radio and Allied Industries

More Efficient Plastics

FOR HIGH FREQUENCY PARTS

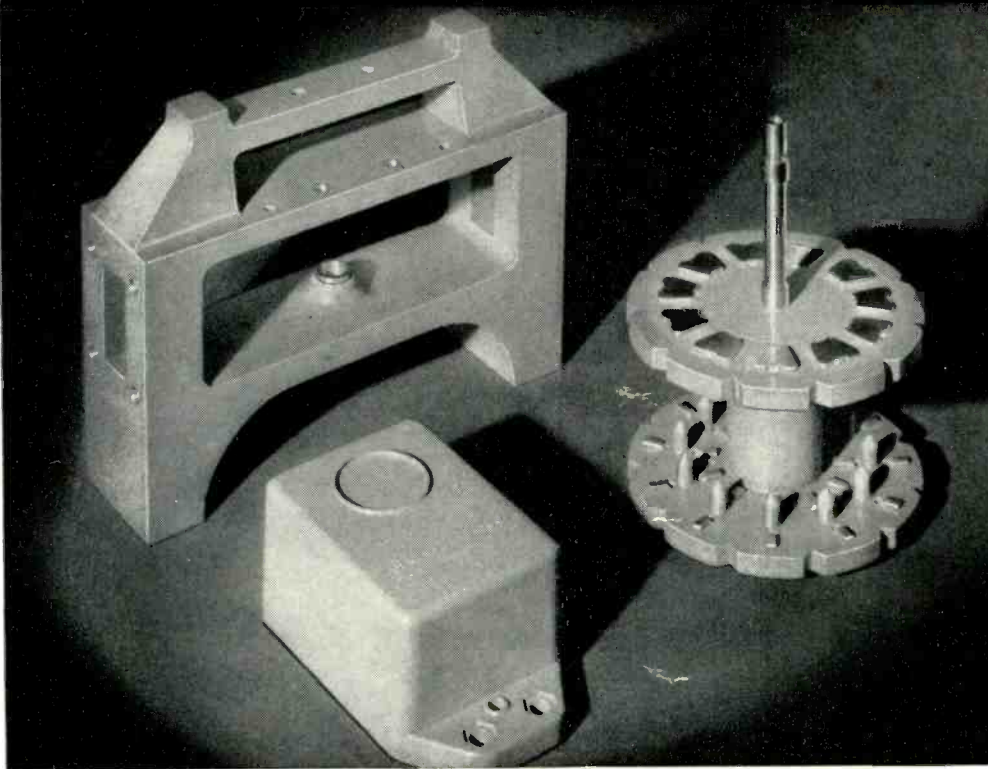

Resistor Drum and Capacitor Frame used in Leeds & Northrup Co. high frequency equipment, molded by Tech-Art Plastic Co.; and General Radio Co. Condenser Case, molded by Ray State Molding Co.

It is quite generally recognized that the dielectric efficiency of any high-frequency electrical part depends not only on the resistivity, but also on the power factor of the material from which the part is made. It is possible that careful study of power losses in many existing electrical parts may lead to significant advances in design.

For the forming of parts in which power losses must be held to a minimum, low-loss Bakelite Molded offers exceptional advantages. This material possesses high resistivity and dielectric strength, and also the lowest power factor of any molded plastic adapted

to the same uses. Its power factor is only 14% that of general purpose Bakelite Materials at one million cycles.

In addition to these electrical merits, low-loss Bakelite Molded possesses other typical advantages of Bakelite Materials...moisture-proofness, chemical resistance, durability and ready adaptability to form. Manufacturers and designers of all types of high-frequency parts are invited to consult us regarding possible benefits of low-loss Bakelite Molded for their products.

Also write for our 48-page illustrated booklet 50M, "Bakelite Molded".

BAKELITE CORPORATION, 247 PARK AVENUE, NEW YORK, N. Y.
BAKELITE CORPORATION OF CANADA, LTD., 163 Dufferin Street, Toronto, Ont.

BAKELITE

The registered trade marks shown above distinguish materials manufactured by Bakelite Corporation. Under the capital "B" is the numerical sign for infinity, or unlimited quantity. It symbolizes the infinite number of present and future uses of Bakelite Corporation's products.



Brush Support for High Frequency Resistance Box

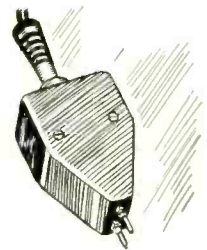

Housing for Vacuum Tube Voltmeter Probe

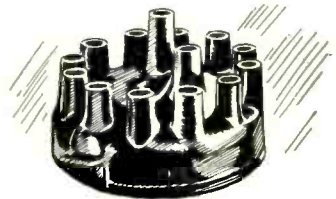

Aircraft Distributor Head



Automobile Running-Board Antenna Insulator

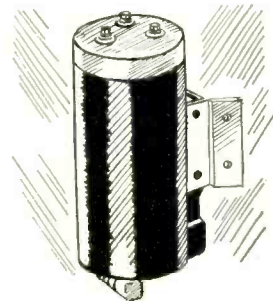

Ignition Coil Cover

Above are five of the many appropriate applications for low-loss Bakelite Molded.

THE MATERIAL OF A THOUSAND USES

*A revolutionary design in radio cabinets
made practicable by*

DUREZ

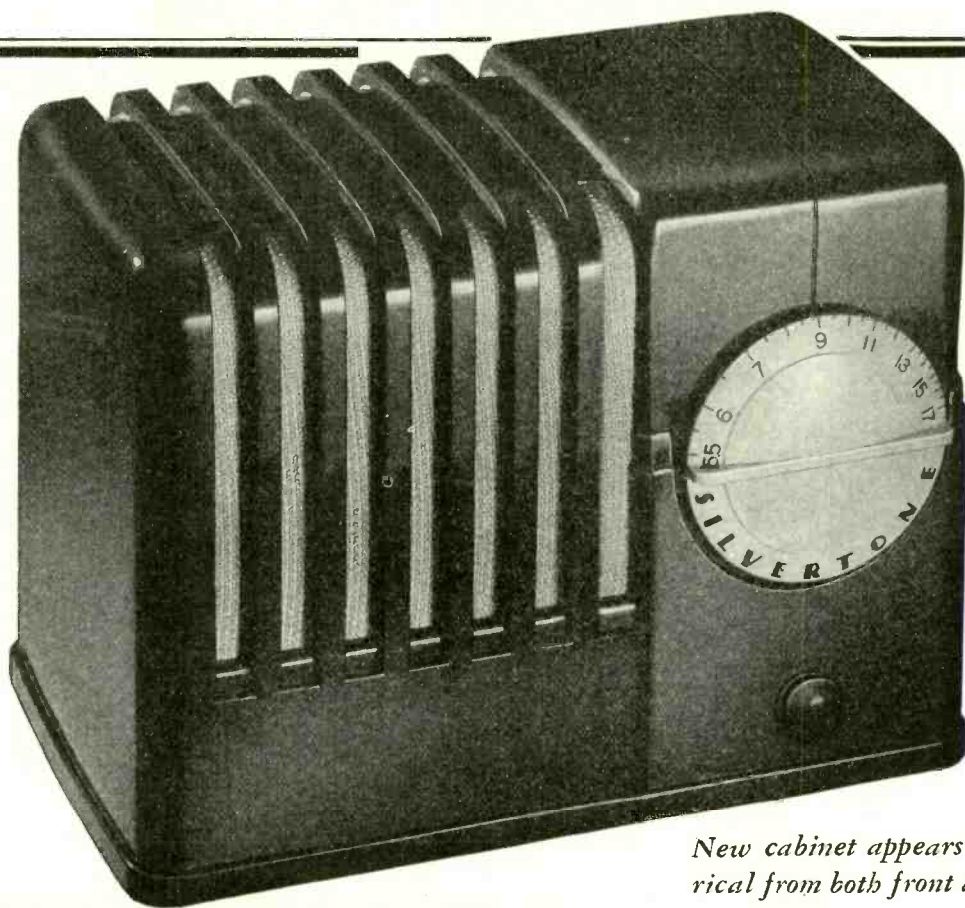

New cabinet appears symmetrical from both front and back

SEAR'S ROEBUCK's Silvertone Compact is a new radio—the first that was ever designed to take advantage of the full possibilities of plastics. Molded of sleek, permanently beautiful Durez, it is built to capitalize on the strength, the light weight, and the eye-catching, beautiful design that Durez makes possible.

The set looks equally well from the front or back, because the chassis goes into the cabinet from the bottom, instead of the side. Here's one radio that can be put in the middle of the table, that never need be stuck away against a wall.

In addition to making this improved design practicable, Durez eliminated the need for special insulation, simpli-

fied production. The entire cabinet is produced in one molding operation... it comes out of the mold fully formed, complete with inserts and the *final* surface finish.

Why not let Durez bring these same advantages to your product? For further information and a copy of the monthly "Durez News," write General Plastics, Inc., 194 Walck Road, North Tonawanda, N. Y.

DUREZ
MOLDING COMPOUNDS

RADIO ENGINEERING

REG. U. S. PATENT OFFICE

W. W. WALTZ • Editor

CONTENTS FOR APRIL

FEATURES

EDITORIAL	4
DISTORTION IN DIODE DETECTOR CIRCUITS By A. W. Barber	7
WELDING STAINLESS STEEL..... By John J. MacKinney	10
GRAPHICAL REPRESENTATION OF BAND-PASS CHARACTERISTICS By Carl V. Erickson	13
THE MANUFACTURE OF CATHODE-RAY TUBES	14
EQUIPMENT AND METHODS USED IN ROUTINE MEASUREMENTS OF LOUDSPEAKER RESPONSE, PART II..... By S. V. Perry	16
REFINEMENTS IN A-C, D-C SET CONSTRUCTION.. By Myron J. Morris	19
EQUIPMENT FOR RADIOTHERAPY..... By Aaron Nadell	20

DEPARTMENTS

NOTES AND COMMENT:	
THE ISOCHROMETER	22
FROM SOME LETTERS ON THE TUBE NUMBERING SYSTEM.....	22
HIGH-FIDELITY SPEAKER	23
RMA NEWS	26
NEWS OF THE INDUSTRY.....	28
NEW PRODUCTS	30
INDEX OF ADVERTISERS	31

Copyright 1937—Bryan Davis Publishing Co., Inc.

COVER ILLUSTRATION

The illustration on our cover shows a test oscillator in operation at the Research & Development Laboratory of the RCA Radiotron Division, RCA Manufacturing Company, Inc. The oscillator uses a pair of developmental water-cooled transmitting triodes designed for ultra-high-frequency operation. This oscillator is capable of producing 1100 watts of useful power in the output circuit at 100 megacycles. The photograph shows a part of the energy being dissipated in a standing arc. The discharge is so intense that small particles of the molten metal are thrown off from the contact wire. The paths of these particles are indicated by streaks surrounding the discharge.

PUBLISHED
MONTHLY

by
the

VOL. XVII

Member Audit Bureau of Circulations

NO. 4

BRYAN S. DAVIS • President SANFORD R. COWAN • Advertising Manager
JAS. A. WALKER • Secretary A. B. CARLSEN • Circulation Manager

BRYAN DAVIS PUBLISHING CO., Inc., 19 East 47th St., NEW YORK CITY Telephone PLaza 3-0483

CHICAGO OFFICE—608 S. Dearborn St.—C. O. Stimpson, Mgr. Telephone: Wabash 1903

CLEVELAND OFFICE—10515 Wilbur Ave.—J. C. Munn, Mgr. Telephone: Republic 0905-J

MELBOURNE, AUSTRALIA—McGill's Agency

WELLINGTON, NEW ZEALAND—Te Aro Book Depot

Entered as second class matter August 26, 1931, at the Post Office at New York, N. Y., under Act of March 3, 1879. Yearly subscription rate \$2.00 in United States and Canada; 25 cents per copy. \$3.00 in foreign countries; 35 cents per copy.

CHINESE COPY



An authentic reproduction of an imported lamp carton label. Due to lack of knowledge of the underlying design principles only 10% of such "Chinese copies" will pass Federal specifications.

"Free from Engineering"

As leaders in transformer development, the UTC Research Staff prides itself on the many revolutionary designs released during the last few years. It is only natural that competitive manufacturers copy these new developments. Some of these copies, however, have low efficiency and poor frequency response. Some have a new gadget, case or terminal arrangement to give the impression of originality, but which only detract from the simplicity and efficiency of the original design. The inferior characteristics of duplicates only bolster the progress of UTC... the line which is a year ahead.

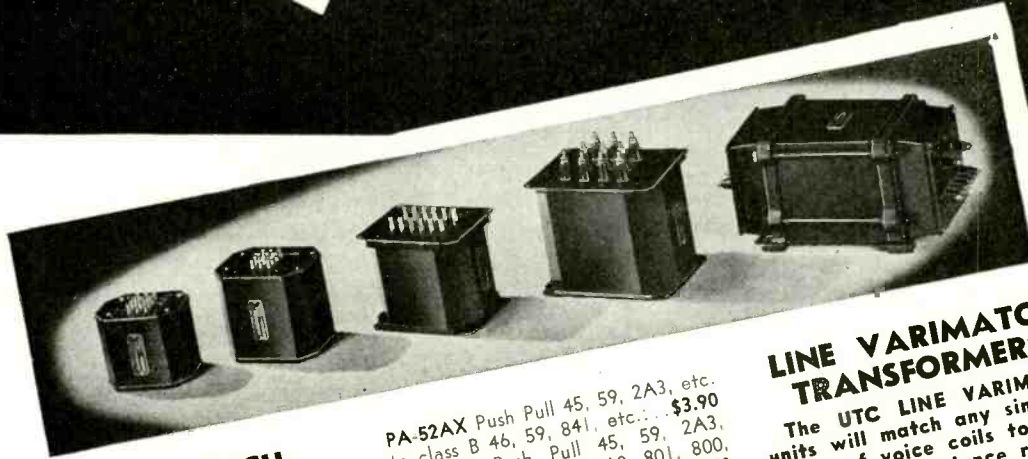

VARIMATCH MODULATION TRANSFORMERS

UTC VARIMATCH Modulation Transformers Will Match ANY Modulator Tubes to ANY RF Load. VM-0 Maximum audio output.

20 watts	\$3.00
VM-1 Maximum audio output	\$4.80
30 watts	\$7.50
VM-2 Maximum audio output	\$12.00
60 watts	\$19.50
VM-3 Maximum audio output	\$42.00
125 watts	
VM-4 Maximum audio output	
300 watts	
VM-5 Maximum audio output	
600 watts	

VARIMATCH INPUT TRANSFORMERS

Varimatch Input Transformers will take care of practically every driver requirement.

PA-50AX Single 89, 53, 56, 6C5, etc. to class B 53, 89, etc.	\$3.30
PA-51AX Single 56, 6C5, 45, 59, 6L6, 2A3, etc. to class B 46, 59, etc., to class B 53, 6A6, 89, etc.	\$3.30

PA-52AX Push Pull 45, 59, 2A3, etc. to class B 46, 59, 841, etc.	\$3.90
PA-53AX Push Pull 45, 59, 2A3, 6L6, etc. to class B 210, 801, 800, 35T, RK-18, 203A, ZB-120, etc.	\$4.50
PA-59AX 500 ohms line to 805, 838, 203A, 210, 800, ZB-120, etc.	\$4.50
PA-238AX Push Pull Parallel 2A3, 6L6, etc. to push pull parallel 838, 23A, ZB-120, or to class B 204A, HF-300, 849, etc.	\$10.50
PA-512 500 ohms line to class B 150T, HF-300, 204-A, etc.	\$12.00

PA VARIMATCH TRANSFORMERS

The new UTC PA Varimatch Transformers will match practically any tube in their power range to a 200/500 ohm line or to any voice coil.

PVM-1 For all audio tubes up to 12 watts	\$3.00
PVM-2 For all audio tubes up to 30 watts	\$4.80
PVM-3 For all audio tubes up to 60 watts	\$7.50
PVM-4 For all audio tubes up to 125 watts	\$12.00
PVM-5 For all audio tubes up to 300 watts	\$19.50

ALL PRICES SHOWN ARE NET

LINE VARIMATCH TRANSFORMERS

The UTC LINE VARIMATCH units will match any single or group of voice coils to a 500 ohm line. Impedance range is from .2 to 75 ohms in 50 combinations... UTC LINE VARIMATCH AUTOFORMERS will match one to ten 500 ohm lines or LVM 500 ohm windings to the 500 ohm output of an audio amplifier.

LVM-1 12 watt Line Varimatch unit	\$2.70
LVM-2 30 watt Line Varimatch unit	\$4.20
LVM-3 50 watt Line Varimatch unit	\$6.00
LVM-10 12 watt Line Varimatch Autoformer 500, 250, 167, 125, 100, 83, 71, 62, 50 ohms	\$2.70
LVM-11 30 watt Line Varimatch Autoformer	\$4.20
LVM-12 60 watt Line Varimatch Autoformer	\$6.00
LVM-13 125 watt Line Varimatch Autoformer	\$10.80
LVM-14 300 watt Line Varimatch Autoformer	\$15.00

NEW VARIMATCH BULLETIN
See your distributor for the new bulletin listing details, valuable application information and technical tables.

UNITED TRANSFORMER CORP.

72 SPRING STREET

NEW YORK, N. Y.

EXPORT DIVISION: 100 VARICK STREET NEW YORK, N. Y. CABLES: "ARLAB"

Editorial

THIS MONTH

DIODE DETECTORS HAVE, since their revival a few years ago, contributed their share of the distortion prevalent in many receivers. The subject has received some little attention—especially in British publications—although by no means the amount which its importance warrants.

Our lead article injects diodes into the limelight once more. It is entirely possible that many of the points discussed by our author are, or were, well known to engineers, but forgotten or discarded in the general rush to turn out new designs. This resume of the subject, along with the suggestions for betterment, will, it is hoped, lead to serious consideration of this source of distortion.

Frankly, we don't know what applications, if any, there may be for stainless steel in radio manufacture, but the material itself is so interesting, as are the things that are being done with "stainless" in other industries, that we have obtained an article on how this metal is welded. After all, it is the fabrication of a material which concerns the prospective user; the fact that "stainless" is electrically welded with the welding time controlled, in many cases, by electronic tubes, should in itself be of interest to the industry.

In addition, there are described the various ways and means of producing—or is inducing the correct term?—artificial fever by high-frequency currents. The recent world congress on radiotherapy has served to focus attention on this relatively new phase of the medical art, and the development of fever equipment—especially interference-free equipment—is properly within the scope of the radio engineering profession.

INTER-COMMUNICATING SYSTEMS

THESE DEVICES MAY be a normal off-shoot of the radio receiver industry, although we feel that they more properly belong to those manufacturers who specialize in audio amplifiers and public address equipment. How-

ever, several set makers have entered the field, and probably others are planning to do so.

There are several points, in connection with the merchandising of this equipment, to which the receiver manufacturer should give serious consideration. First and foremost is: How are the systems to be sold; that is, will the manufacturer expect his retail outlets which already may be appliance stores with radio as a sideline, or radio stores with appliances as the sideline, to assume the job of plugging this new line? Such a dealer, in order to have any appreciable turnover, would have to increase his selling staff and put men out on the street in a straight office-to-office canvass. Add to this the headaches occasioned by the inevitable service calls—can't you just picture the office blonde trying to fix the gadget with the customary hairpin?—and, to our way of thinking, the radio retailer will soon be ready to call it off.

On the other hand, how about the ubiquitous service man? Here, it would seem, is a natural outlet for the inter-communicating system. He, the service man, is probably well known around his neighborhood; he probably has the time or can easily get the help necessary to push the equipment aggressively; and he is, of course, pre-eminently fitted to the job of changing the tubes, or of any other field repairs.

The big problem, from the service man's standpoint, is that of financing the deal. We don't mean financing in the sense of installment selling to the user, but rather of initially obtaining the equipment to sell. We suspect that many service organizations do not have the necessary credit rating to obtain stocks of the equipment; this puts the problem squarely up to the maker.

The answer, of course, lies in some kind of a consignment plan. This usually presupposes a satisfactory credit standing, but in this case the customary consignment idea can be modified to the extent of making consignment shipment on one model system to be used for demonstration purposes.

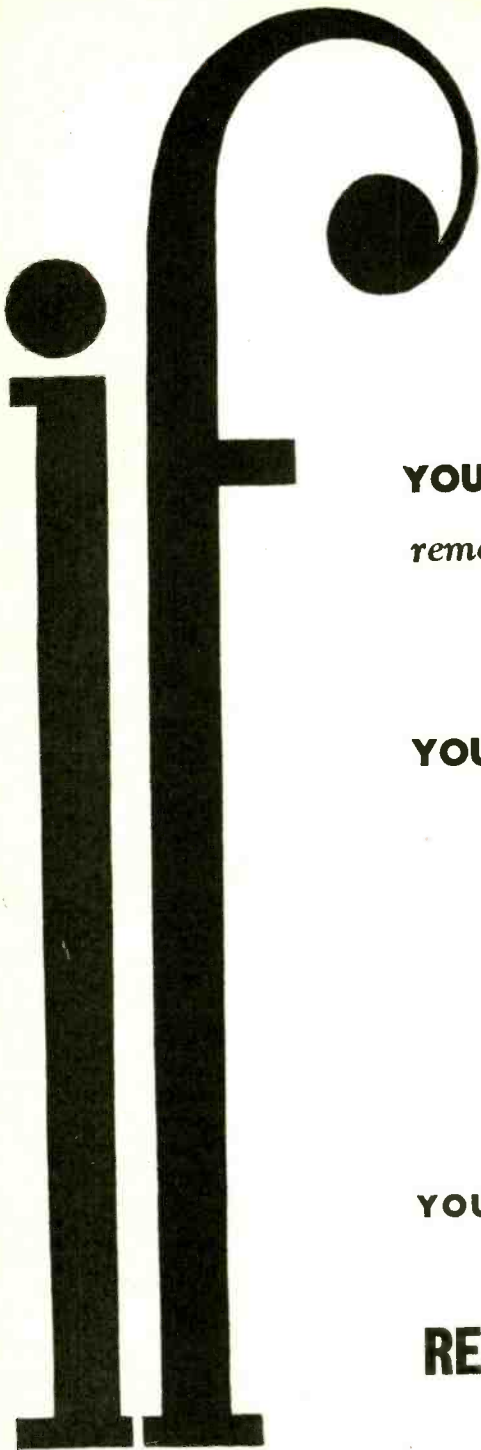

YOU SELL RAW OR FABRICATED MATERIALS

remember that 2150 component parts, tube and radio device manufacturers bought over \$94,000,000 worth of materials in 1936. RADIO ENGINEERING influences these manufacturers in their purchases.

YOU SELL COMPONENT PARTS

994 radio receiver, public address, speech amplification, broadcast transmitter and electronic device manufacturers bought over \$323,000,000 worth of component parts last year. Every important executive, chief engineer and production manager must be reminded constantly about your products and new developments. RADIO ENGINEERING will carry your sales message to many laboratories and offices where your representative cannot gain admission.

**YOU WANT TO SELL YOUR PRODUCTS TO ALL THE
COMPANIES THAT MANUFACTURE**

**RECEIVERS - TUBES • COMPONENTS
• ELECTRONIC DEVICES •**

One Magazine . . . RADIO ENGINEERING should carry your advertising for sales-producing results at low cost.

Take advantage of the extra distribution afforded by our MAY ISSUE . . . *The Annual Institute of Radio Engineers Convention Number.*

ADVERTISING FORMS CLOSE MAY 1ST

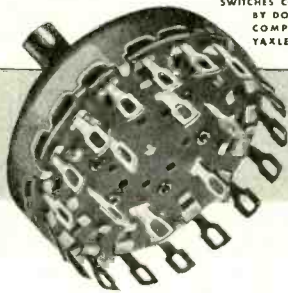
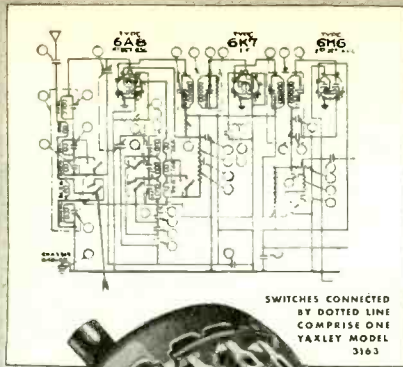

TYPE 3100
(Large Base)

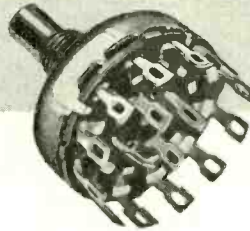
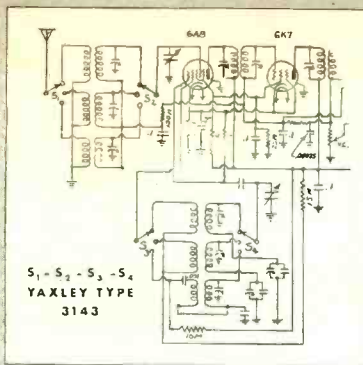

TYPE 3100
(Small Base)

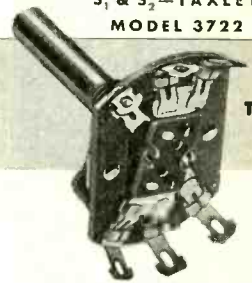
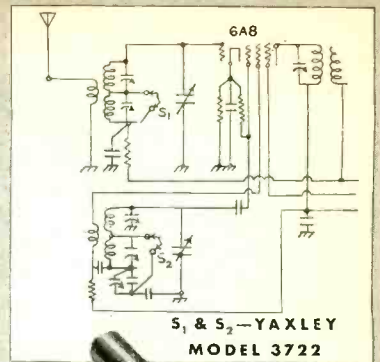

TYPE 3700

5 Reasons Why **YAXLEY** ALL-WAVE SWITCHES

Provide *Extreme Circuit Flexibility*

Each type of Yaxley Switch on this page performs more satisfactorily or economically in the typical circuit shown than any other available switch. These are not hypothetical examples, but are taken from actual receivers in which the respective switches are now successfully employed.

Type 3100 (Large Base)—A maximum of 18 positions on a 1¹¹/₁₆" base. Provides more switching combinations in a single section than may be obtained by any other switch. Circuit shown is typical of its extreme adaptability.

Type 3100 (Small Base)—Accomplishes large switch performance in a miniature size. Provides a maximum of 12 positions on a 1/4" base—a feat unduplicated by any other switch.

Type 3700—One of 22 standard constructions. Engineered especially for small chassis. Type 3700 has a maxi-

imum of 6 terminals. Accompanying circuit shows an actual wave-change application. Other switches of this series are adapted to tone control and tap switch requirements.

Type RM—Provides an almost limitless number of switching combinations through the use of back insulated contacts and interconnected rotor shoes. Diagram illustrates an entire 3-band receiver, the circuit switching of which is accomplished by a single RM section.

Type RL—Long production experience on this type has made it the standard of switch perfection. A stationary collector ring, not part of the rotor, makes more positions available—especially when all unused coils are to be shorted.

Large inventories of all parts for these switches assure you low cost and prompt deliveries. The Yaxley Manufacturing Division of P. R. Mallory welcomes your switch problems—send your circuit diagram and switch dimensions.

P. R. MALLORY & CO., Inc.
MALLORY

P. R. MALLORY & CO., Inc.
INDIANAPOLIS, INDIANA
Cable Address—PELMALLO

YAXLEY

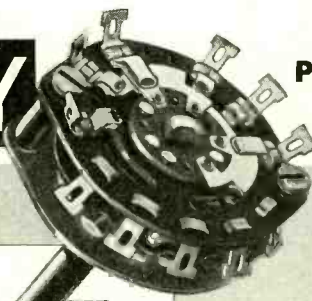

TYPE RM

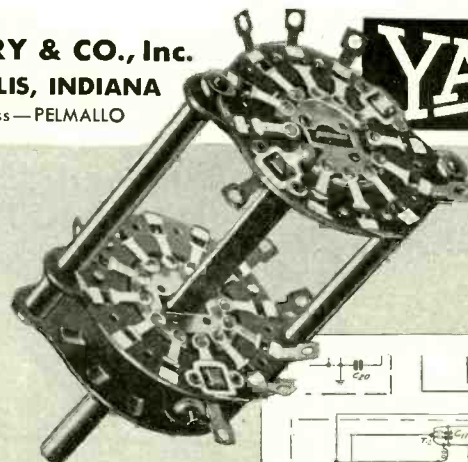

TYPE RL

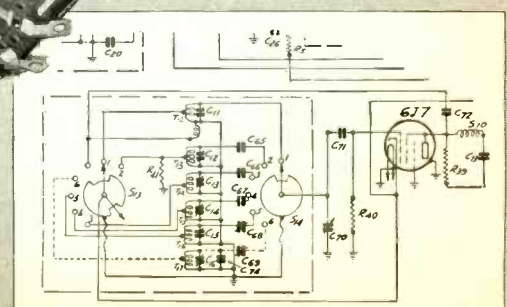
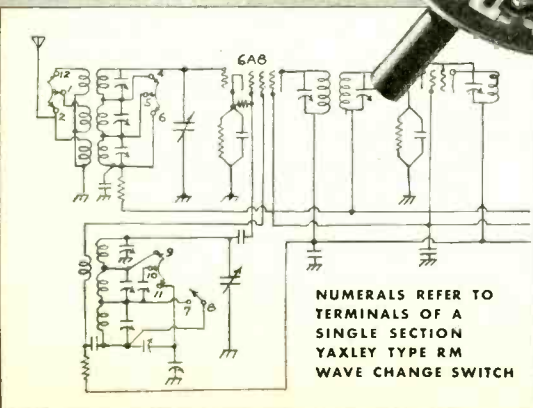

RADIO ENGINEERING

FOR APRIL, 1937

DISTORTION IN DIODE DETECTOR CIRCUITS

by A. W. Barber*

WHILE MUCH HAS been written about diode detectors, and they are almost universally used in radio receivers, a complete and rigorous analysis of their operation is very difficult to carry out. It is possible, however, to analyze completely for the purposes of circuit design. It is the purpose of this article to show an analysis which is as complete as is necessary for design purposes and to point out and evaluate the distortion caused by the automatic volume control filter and audio coupling circuit commonly used with diode detectors. Finally a circuit will be shown which is free from these distortions.

The diode circuits to be discussed are of the linear type, that is, the type having a relatively large load resistor in which the rectified voltage drop approaches the peak of the applied radio-frequency voltage. Fig. 1 shows the basic circuit to be considered in which unmodulated input voltage is developed across the tuned circuit L_1C_1 and is applied to the diode having plate P and cathode K in series with the load resistor R by-passed by condenser C_2 . The diode should be conducting to voltages which make its plate P positive with respect to its cathode K and non-conducting to all other voltages. The diode resistance during conduction should be low compared to R and constant for efficient distortionless detection. The detection process consists simply in charging condenser C_2 through the diode resistance during a part of

* Consulting Engineer.

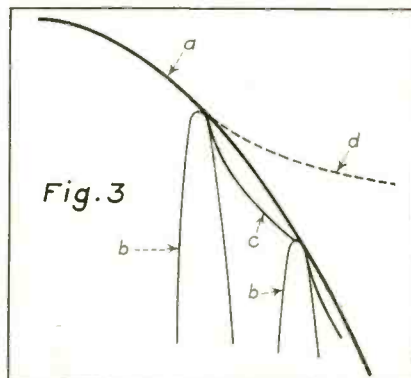
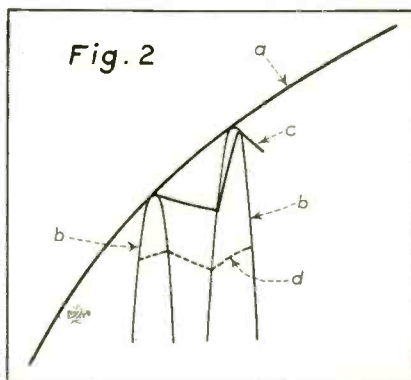
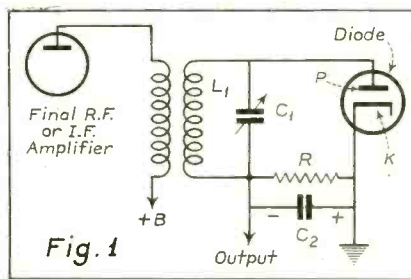

each positive radio-frequency cycle and permitting it to discharge through the resistor R during the remainder of the radio-frequency cycle.

Fig. 2 shows a part of the rising side of a modulation envelope "a" and the peaks of two component radio-frequency waves "b." The curve "c" shows the voltage across the diode load condenser C_2 which rises on each radio-frequency peak and falls exponentially between peaks. The resultant condenser voltage is a modulation-frequency wave with a radio-frequency serration which latter is either filtered out or not passed by amplifiers following the detector. If the diode resistance during the conducting part of the radio-frequency cycle is too high, condenser C_2 is not sufficiently charged on each radio-frequency peak, but follows the dotted curve "d" which shows a reduced and distorted modulation-frequency output. Actually this requirement of low diode resistance during detection is easily met by commercially available diodes and many other tubes used as diodes, hence, the requirement will not be further considered.

Fig. 3 shows the falling side of the modulation envelope "a" with two component radio-frequency peaks "b." If the diode load condenser C_2 discharges through load resistance R fast enough, the condenser voltage keeps within the modulation envelope as shown by "c." If, however, R is too large, C_2 does not discharge as fast as the modulation falls and its voltage goes outside the modulation envelope as shown by curve "d."

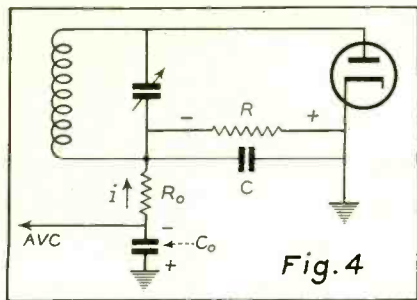

Fig. 4

This inability to follow the modulation envelope results in an attenuation and distortion of modulation voltages for all modulation frequencies above the point at which this failure to follow, on the part of the condenser voltage, starts to occur.

Since this requirement of following the modulation envelope is an important design consideration it is desirable to analyze it mathematically.

The positive half of the modulation envelope may be expressed as,

$$e_1 = E_1 (1 + m \sin 2\pi f_1 t)$$

where m is the modulation factor and f_1 is the low or audio modulation frequency. The rate of change or slope of the modulation envelope is therefore,

$$\frac{de_1}{dt} = 2\pi f_1 m E_1 \cos 2\pi f_1 t$$

The maximum rate of change occurs at values of t which make $\cos 2\pi f_1 t$ equal to 1 and for m equal to 1. This maximum rate of change of the envelope is then,

$$2\pi f_1 E_1$$

The voltage across C_2 during its discharge is,

$$e_2 = E_2 \epsilon^{-\frac{t}{C_2 R}}$$

and its rate of change is,

$$\frac{dt}{de_2} = -\frac{E_2}{C_2 R} \epsilon^{-\frac{t}{C_2 R}}$$

The initial rate of change of the condenser voltage is,

$$-\frac{E_2}{C_2 R}$$

Now on the falling side of the modulation envelope its slope is negative and has thus a maximum value,

$$-2\pi f_1 E_1$$

For a completely modulated wave $m = 1$ and $E_1 = E_2$ and hence by equating the slope of the modulation envelope and the

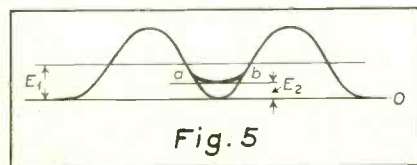

Fig. 5

discharge of the diode condenser we have the condition to be met,

$$-2\pi f_1 E_1 = -\frac{E_2}{C_2 R} = -\frac{E_1}{C_2 R}$$

or

$$2\pi f_1 C_2 = \frac{1}{R}$$

or

$$R = \frac{1}{2\pi f_1 C_2} = X_{C_2}$$

where f_1 is the highest desired modulation frequency. Thus in order to follow the modulation envelope the diode load condenser reactance at the highest desired modulation frequency must be equal to, or not less than, the load resistance in absolute value. Table I shows the proper load resistances computed on the above basis for maximum modulation frequencies of 5,000 and 10,000 cycles for various condenser values from 10 to 1,000 micro-microfarads.

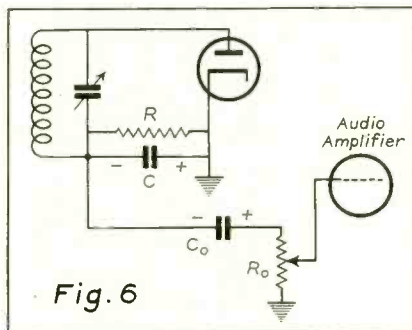

Fig. 6

It is desirable to know the effective input resistance of a diode detector circuit and it may be derived from a consideration of power dissipation in the circuit.

Let R' = the effective diode circuit input resistance

e_1 = the rms radio-frequency input voltage

R = the diode load resistance

E = the d-c voltage across the diode load R

For diode circuits having a high detection efficiency,

$$E = 1.4 e_1$$

The power dissipated in the diode load in a high efficiency detection circuit may be assumed to be essentially the total power dissipation in the circuit and has a value,

$$P_r = \frac{E^2}{R} = \frac{2e_1^2}{R}$$

The power dissipated in an equivalent resistance R' shunting the tuned input circuit will be,

$$P_{r'} = \frac{e_1^2}{R'}$$

Equating these two powers yields the result,

$$\frac{2e_1^2}{R} = \frac{e_1^2}{R'}$$

and hence,

$$R' = \frac{R}{2}$$

Thus in an efficient linear diode detector circuit the effective input resistance is equal to one half the diode load resistance.

While increasing the diode load resistance R increases the diode efficiency and the gain of the amplifier feeding the circuit it decreases the load condenser C_2 required for high-frequency fidelity. Since the diode input capacity C' becomes effective in passing radio-frequency voltage to the output circuit by a factor $C'/C_2 + C$ there is a limit on the maximum value of R which may be desirable. Also, since the diode effective load R' is in parallel with the tuned input circuit having an equivalent tuned impedance of R'' it will not increase the actual diode detector output to make R' much greater than $2R''$. Taking all these factors into consideration a resistance $R = 500,000$ ohms and a capacity $C = 50$ mmf seems to be a good practical compromise for the diode load when used with standard tubes and conventional circuits.

Fig. 4 shows a typical diode detector with load resistor R and load condenser C with an automatic volume control filter consisting of resistor R_o and condenser C_o connected in series and effectively in parallel with the diode load RC . This innocent looking circuit is a potential source of serious distortion. In general, condenser C_o is large compared to C and it will charge to a voltage E_1 equal to the average of the positive half of the modulation envelope as shown in Fig. 5, where is represented the positive half of a modulation envelope. This positive half of the envelope may also be taken to represent the instantaneous voltage across the diode load. While the diode load voltage is greater than E_1 , condenser C_o will charge through resistor R_o . On the other hand, when the instantaneous diode load voltage drops below E_1 , con-

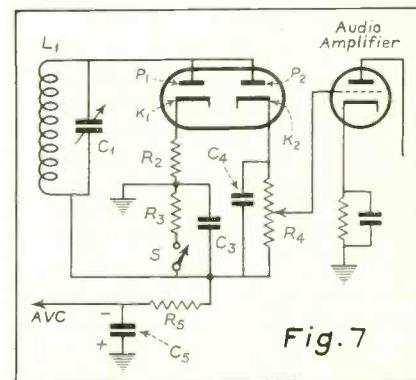

Fig. 7

Load Condenser	Load Resistance for Mod. Freq. = 5000 ~	Load Resistance for Mod. Freq. = 10,000 ~
10 Mmfd.	3,200,000 Ohms	1,600,000 Ohms
50 "	640,000 "	320,000 "
100 "	320,000 "	160,000 "
250 "	128,000 "	64,000 "
500 "	64,000 "	32,000 "
1000 "	32,000 "	16,000 "

denser C_0 will start to discharge through resistors R_0 and R in series. The drop across R due to this discharge will be equal to $E_1 R/R_0 + R = E_2$ and will be in such a direction as to make the diode plate negative with respect to its cathode. Thus, when the instantaneous diode load voltage drops below E_2 , the diode will be cut off and the negative part of the modulation peak will be cut off as shown "a" to "b" in Fig. 5. This cut-off is very sharp and hence generates a large number of high-order and very objectionable harmonics. The modulation at which this cut-off occurs is,

$$m = \frac{E_1 - E_2}{E_1} = \frac{E_1 - \frac{E_1 R}{R_0 + R}}{E_1} = \frac{R_0 + R - R}{R_0 + R} = \frac{R_0}{R_0 + R}$$

We may thus predict the maximum undistorted modulation percentage which will be handled by the detector. Table II shows the relation between tolerable or undistorted modulation factor m and various values of R and R_0 .

Fig. 6 shows a simple diode circuit feeding an audio amplifier by means of a coupling condenser C_0 and a volume

control potentiometer R_0 . It will be seen that this circuit is the exact equivalent of the avc filter circuit and feeds back a cut-off bias in exactly the same manner. We may then find the total feedback effect by adding the effects of the avc filter and audio coupling systems. This may be done by computing the equivalent resistance of the avc filter resistor in parallel with the audio amplifier grid resistor or volume control and using this equivalent resistance for R_0 in applying Table II. Thus a diode load resistor of 500000 ohms with a 1-megohm avc filter resistor and a 1-megohm audio volume control resistor will start to cut off at 50 percent modulation. Using a duo-diode with a 1-megohm load in each diode circuit and a 1-megohm filter and audio resistor gives exactly the same 50 percent modulation limit.

Fig. 7 shows a diode detector circuit which overcomes the cut-off distortion limitation. The input circuit $L_1 C_1$ feeds the two diodes $P_1 K_1$ and $P_2 K_2$ each having its own load circuit. The first diode $P_1 K_1$ has a high time-constant load consisting of condenser C_2 and resistor R_2 which may be 0.1 microfarad and 1 megohm respectively. This load generates a steady voltage suitable for automatic volume control purposes. If the positive or cathode end of the load is grounded the negative end may be used for avc through the filter $R_1 C_3$. This avc filter will not cause cut-off distortion since the feedback from C_3 must charge C_2 through resistor R_2 and the time constant of $C_2 R_2$ may be made high making the feedback ineffective for normal modulation frequencies. The use of resistor R_2 effectively prevents the $C_2 R_2$ load from reflecting any large change in load across the radio-frequency input circuit. The audio volt-

R	R_0	Max. Undistorted Modulation Factor, m
100,000 Ohms	250,000 Ohms	0.715
" "	500,000 "	0.835
" "	1,000,000 "	0.910
250,000 Ohms	250,000 Ohms	0.500
" "	500,000 "	0.667
" "	1,000,000 "	0.800
500,000 Ohms	250,000 Ohms	0.333
" "	500,000 "	0.500
" "	1,000,000 "	0.667

age is generated across the load in the second diode circuit consisting of condenser C_4 and resistor R_4 . The audio volume control resistor R_4 is the diode load resistor and no coupling condenser is employed, permitting the use of a high value of resistance without cut-off difficulties. The steady component of rectification generated in the audio circuit is effectively cancelled by returning R_4 to the negative end of the avc load C_3 . Thus in going from ground through C_3 and C_4 to K_2 the steady components of rectification oppose each other leaving a net audio voltage for application to the grid of the audio amplifier tube. At reduced volume control settings the audio grid receives an increased negative bias component which may or may not be desirable. If it is desired to prevent the bias change, the volume control may be placed on the input to the second audio amplifier tube or the return point of the audio load to the avc circuit may be varied in step with the audio control setting. If automatic bias is used in the audio amplifier cathode circuit, as shown, the variation in grid bias will be largely counteracted by the cathode bias changes. Switch S may be opened in order to fix the automatic volume control for tuning purposes. (See RADIO ENGINEERING, Sept. 1936).

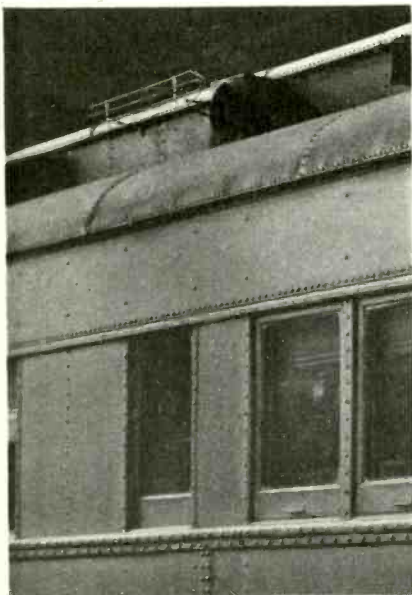

Installation of an especially designed seven-tube Crosley receiver on the Diplomat Limited of the B & O. The antenna (left) is of the standard automobile undercar type about three and one-half feet long; it is placed horizontally and lengthwise of the car, only a few inches above the roof at the lower side.

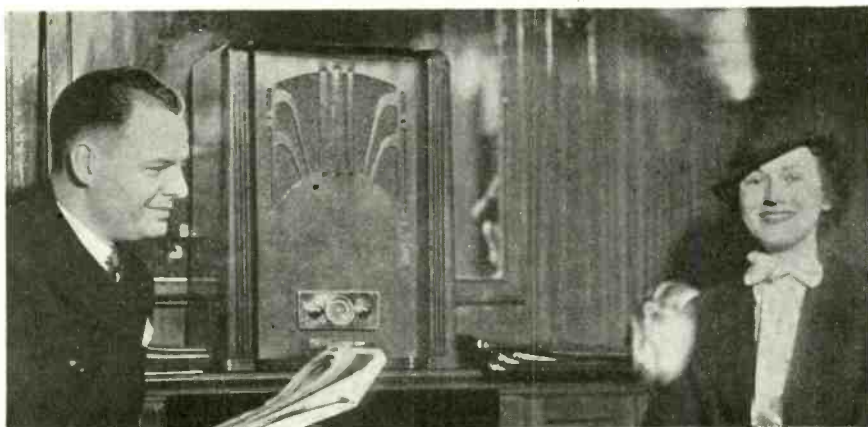

WELDING STAINLESS STEEL

SPOT WELDING is a method of joining overlapping sheets or plates of metal wherein regularly spaced circular areas of the abutting surfaces are welded. It is done by gripping the joint between two circular electrodes of hardened copper or copper alloy and passing through the metal an extremely high current at a low voltage. As in any resistance weld, the heat generated is proportional to $I^2 R T$, where I is the welding current, R is the resistance between the electrodes, and T is the time of current application. The trade name "Shotweld" refers to the exclusive process of control of welding and its equipment as achieved by the Edw. G. Budd Manufacturing Co. According to the Budd method, the time T is a very small fraction of a second, and all conditions of current application are accurately controlled.

The equipment necessary for welding by the "Shotweld" process consists of three parts; namely, transformer, timer and tool.

Fig. 1 shows the complete assembly of these three, being used to weld two thicknesses of .010" high tensile chromium-nickel (18-8) steel. The transformer and mechanical timer, in this case, are assembled as a unit in the portable cabinet on the right. In Fig. 2, the panel is removed, showing the transformer in the bottom, and the timer on the top. This is a ten kva transformer operated at a primary voltage of 220 volts. The open circuit secondary voltage can be varied in eleven steps by means of a selective switch in the primary circuit; these eleven taps can be seen in Fig. 2 in the lower right side of the cabinet.

Fig. 3 shows the timer removed from the cabinet; this is known as the Budd Mechanical Timer. The synchronous motor A drives contact brush B , at a definite speed, through the reducing gear C . When the control button, lower left of Fig. 2, is closed, the solenoid D closes the cam latch E , causing the shaft and rotating brush to move forward and make contact with the copper segments F . This closes the primary circuit from a pre-determined advance segment until the brush has passed

*Edward G. Budd Mfg. Co.

by John J. MacKinney*

over the last segment, at which time the primary circuit is opened and the cam latch is released. The relays in the control button circuit are so arranged that the cam latch is released in order that the brush will not make contact on the next revolution, thus preventing repeat welding. To make another weld, the control button must be opened and again closed. The time of contact, or welding time, is determined by the speed of the brush (rpm) and the number of contact segments included in the circuit. This timer and transformer may be built in any size depending upon the capacity necessary to meet the requirements for good welding.

There are several electron-tube timers employed in resistance welding. One of these, a Westinghouse product, is known as the "Ignitron" tube timer. Like the mechanical timer, it acts as a switch connected in series with the power source and the primary of the welding transformer. The primary current is carried and interrupted by two "Ignitron" tubes connected in parallel inverse relation. These "Ignitron" tubes are of the mercury-pool cathode type rectifier. Each tube is fired for its half cycle by passing a small ignition current through a crystal that is dipped in the mercury pool. There is a set of timing and control tubes which serve to pass the ignition current. Both the timing and control tubes are of the mercury-vapor arc-discharge type, provided with hot cathode or filament, and grid control. This timer has been described more fully by Stoddard¹ and Dawson².

The pedestal tool in Fig. 1 is a common type used in the Budd shops for welding pieces of light material (0.005" up to 0.030" thickness). The foot pedal compresses the spring applying pressure to the electrodes through the lever arm, and closes the control switch when the spring is compressed the required amount.

In cases where the job is too big to carry to the tool, a portable tool is used. These portable tools vary extremely in their design, especially to meet such extreme

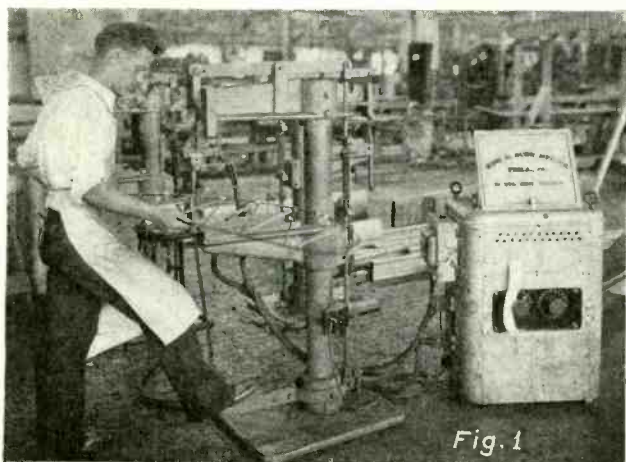

Fig. 1

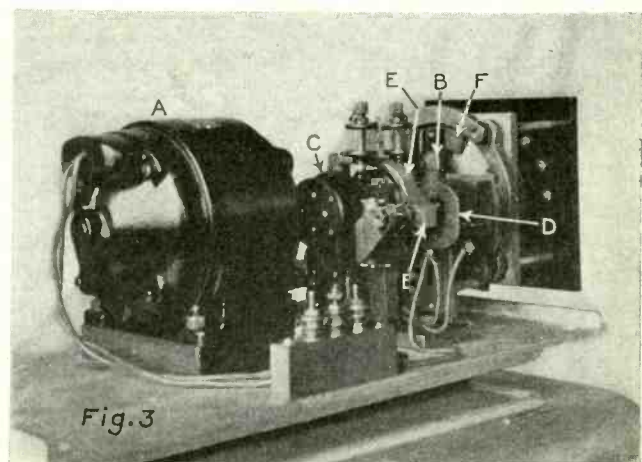

Fig. 3

"Stainless" May Have Some Interesting Possibilities for Radio. The Obvious Method of Fabrication Is by Welding. Here Is How It's Done.

variables in the work as gauge of material, cross-section of the fabricated structure at the weld, relative accessibility, reach to the weld, location, etc. However, they nearly all operate on the principle of one fixed electrode and one pressure or movable electrode, and use an air cylinder to move the electrode and maintain the electrode pressure. Similar to the pedestal tool, the pressure is first applied, then the control switch is closed. This is done in one manual operation.

To weld 18-8 stainless steel satisfactorily, it is necessary to control the welding heat. To explain why this heat control is necessary, it is important to understand some of the metallurgical properties of this steel. In its annealed state (annealing temperature 1800° F to 2100° F), it consists of a single phase known as austenite, and when in this condition, it possesses maximum softness and corrosion resistance. Austenitic steel is a solid solution of iron, carbon and the alloy ingredients. This austenite is completely stable up to approximately 800° F; that is to say, the solid solution is stable. However, between 800° and 1600° F, when the content of carbon is above 0.02 percent, the carbon comes out of the solid solution as a carbide, forming along the grain boundaries and slip planes. The formation of such carbides, especially when the carbon content is higher, draws heavily upon the chromium content of the metal adjacent to the carbide particle, thereby impoverishing the metal in chromium below the required amount for corrosion resistance. This condition can be so severe that some corrosion media will completely disintegrate the metal. This carbide precipitation may be corrected by further heating to the annealing temperature and quenching in water. Heating above the precipitation temperature range makes the carbon go back into solid solution with the iron, and sudden cooling by quenching through this range prevents the carbon from precipitating. However, this can not be done to products of cold worked stock without destroying the desirable cold work.

According to the "Shotwell" system, a carbide precipitation is prevented when welding this steel. Fig. 4A

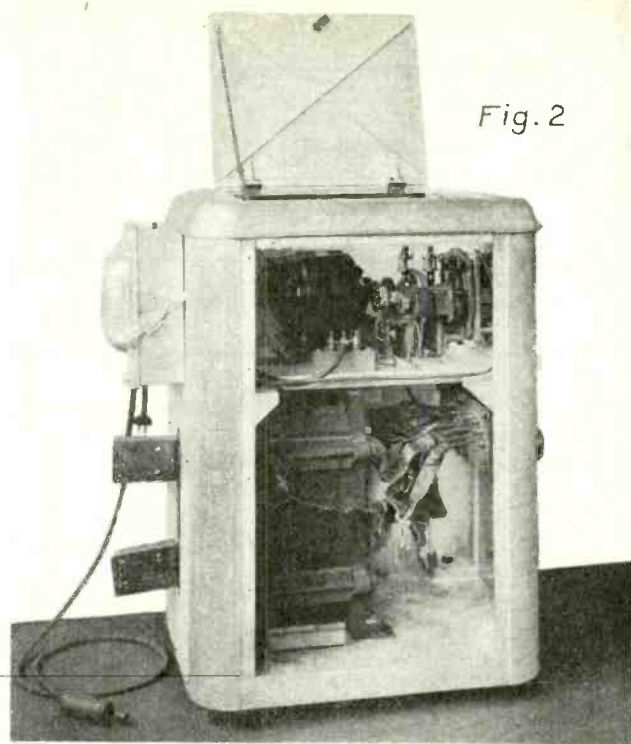
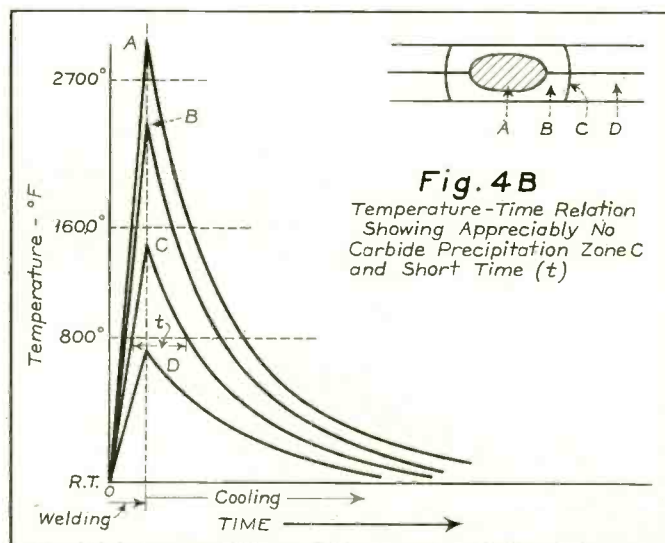
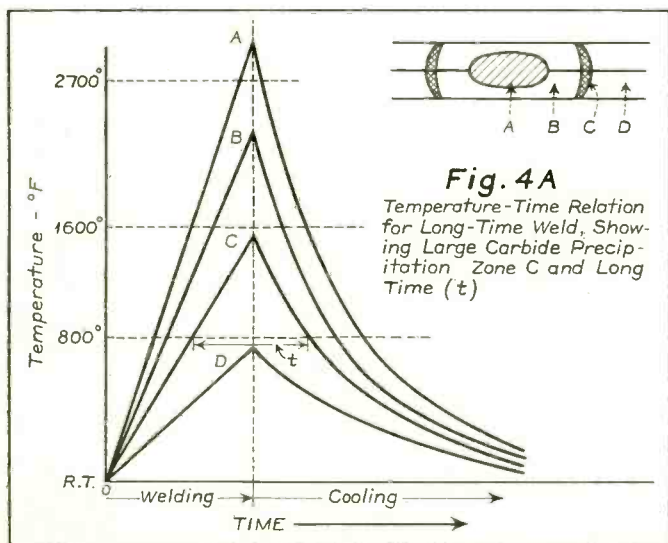
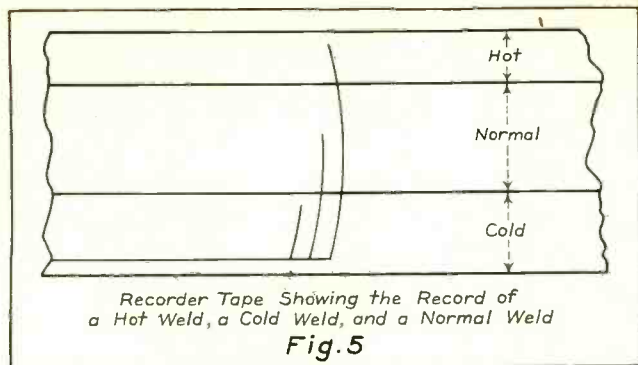

Fig. 2

is a rough graph showing the relation of temperature to time for various sections of a long-time weld made in high tensile 18-8 steel. The accompanying weld shows the position of these sections. Metal A is the fused metal or slug. This metal is raised to the fusion temperature and cools rapidly. Its total time in the precipitation range, on cooling, is so short as to prevent carbides. It is in the annealed state, soft and ductile (Rockwell 80-B, and 80000 psi). Section B is known as the annealed area. Here again, the metal passes through the precipitation temperature range very rapidly on both heating and cooling, preventing carbide precipitation. Like the slug, it is soft and very ductile. Section C is known as the carbide precipitation zone. Here the metal reaches the precipitation temperature range and remains there until cooling. The degree of precipitation is proportional to t . Carbides precipitate along the grain boundaries and slip planes forming a band around the fused slug that has lost its corrosion resistant properties





and is subject to intergranular corrosion. Section D never reaches the precipitation temperature or the annealing temperature, hence, retains its properties as high tensile steel (Rockwell 30-C, and tensile strength approximately 150,000 psi). Fig. 4B serves to illustrate how t is greatly reduced by decreasing the welding time to a small fraction of that shown in Figure 4A.

It is this carbide precipitation zone C that makes it important to control the welding time when welding 18-8 stainless steel. For instance, in arc welding and gas welding, the precipitation time t is very long. It is necessary to heat a large volume of metal, and this heat must be held while the bead is laid. The weld cools slowly, because of the continuous application of heat, hence the precipitation is very severe. In spot welding, the cooling time is shorter than it is in either arc or gas welding, but the uncontrolled times of heating may make the welding portion of t very long, so long as to cause deleterious precipitation. With "Shotweld" equipment the welding time is made so short, along with quick cooling, that the time t of zone C in the temperature range 800° F to 1600° F (Fig. 4B) is decreased below that value which will produce deleterious precipitation. The welding times for thicknesses in the neighborhood of .025" are as low as 1/30 of a second, or 2 cycles of 60-cycle power.

The "Shotweld" system of fabrication is a relatively simple one. The equipment, discussed in the foregoing paragraphs, is entirely automatic in its operation. The operator need not be a skilled welder; for there is substantially no personal element in this type of welding. He needs only to know the correct settings, that is, what time, what pressure, and what current to use for welding a certain thickness of steel. Once these settings are made, he places the work between the dies, applies the pressure, and closes the control button. His principle care after that is keeping the welding dies dressed. To get the correct settings, he consults a chart which gives the time, pressure, and shear strength for the various

thickness of metal. He makes the pressure and time settings from this chart and adjusts the current in order to obtain the specified shear strength. When this is done he has what is considered the optimum weld. To insure this optimum weld for each operation, the apparatus is equipped with a recording device that gives an audible warning when the welding heat increases or decreases due to a change in either I, R or T. A bell is used as the audible warning and continue to ring until the operator makes the necessary correction. Since T, welding time, is very accurately measured by the timer, this variation in heat is most always due to a change in I. He can tell from a recording tape, Fig. 5, whether his heat is high or low. A common cause of variation in heat is line voltage fluctuation; therefore, the correction is usually made by increasing or decreasing the welding current.

The optimum weld thus obtained must meet three requirements, namely, shear strength, percent fusion, and surface appearance. The shear strength required varies with the thickness of the metal, that is, increasing strength for increasing thickness. To test the strength, a weld is made in test pieces of the same thickness as the work and pulled in a convenient tensile machine to determine its breaking load.

The percent fusion is important in that a good weld should twist, in the plane of the abutting surfaces, through an angle of 60 degrees for large welds, and 90 degrees for small welds. This twist test is very significant, since a weld may have enough fused area to meet the load requirement, and yet possess insufficient fusion to be ductile. Ductility is one of the desirable physical properties obtained in welding 18-8 metal.

Surface appearance is not a good criterion for good welding. It is very possible for two welds to look alike, yet differ greatly in each of corrosion resistance, shear strength, and percent fusion. Many jobs require a neat appearing surface, in which case the optimum weld must not show bad die penetration or burning.

Fig. 6 shows three different welds made in .010" metal. A is an example of a hot weld. This weld is strong, but the fusion has come through to the surface giving a bad appearance. This also causes excessive electrode wear, which requires more frequent dressing. B is an example of a good weld. It will pull the required load, twist 90 degrees and has a neat surface. C is a cold weld. Although this weld looks good on the surface, the fusion has not penetrated the metal enough to give the desired strength and ductility.

REFERENCES:

- ¹A New Timer for Resistance Welding, R. N. Stoddard. Electrical Engineering (AIEE Transactions), Vol. 53, October 1934, pp. 1366-70.
- ²New Developments in Ignitron Welding Control, J. W. Dawson. Electrical Engineering (AIEE Transactions), Vol. 55, December 1936, pp. 1371-78.

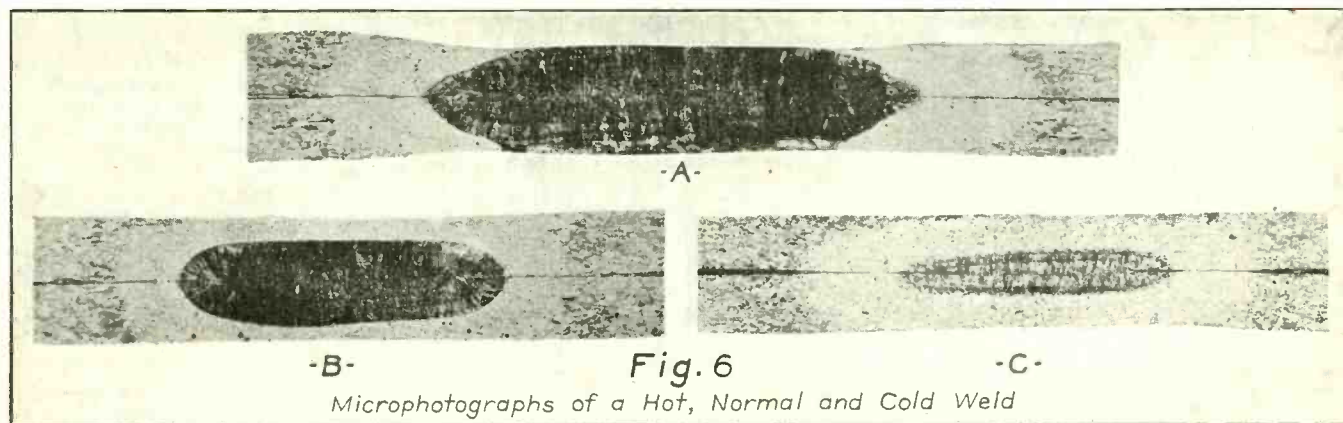

GRAPHICAL REPRESENTATION OF BAND-PASS CHARACTERISTICS

Concluding an Important Analytical Method

by Carl V. Erickson

FOR COUPLING of the type shown in Fig. 3, the response is

$$\frac{I_2}{I_P} = \frac{-jZ_M/\omega C_1}{Z_1 Z_2 + Z_M (Z_1 + Z_2)}$$

If Z_M is pure resistance, the value of Δf_1 is

$$\frac{R_{\alpha, \beta} + R_M}{2\pi L}$$

This changes for any change of coupling R_M . The origin of the vector does not fall on the line representing the coupling, but is somewhere on the line representing the value of R^2 on the chart. Specifically, the origin of the vector is

$$\frac{R^2_{\alpha, \beta} + 2R_{\alpha, \beta} R_M}{R^2_{\alpha, \beta} + 2R_{\alpha, \beta} R_M + R^2_M}$$

of R^2 from the apex of the parabola.

If Z_M is capacitive or inductive, the response may be expressed as

$$\frac{I_2}{I_P} = \frac{-jZ_M/\omega_0 C}{R^2 - Z_M^2 - (4\pi\Delta f_1 L)^2 + j2R(4\pi\Delta f_1 L)}$$

Here, $-Z_M^2$ becomes positive, and may be evaluated in terms of R^2 for determining the coupling. The chart is shifted with reference to the frequency scale by the

value of $\frac{jZ_M}{4\pi L}$. This is noted by employing Δf_1 instead of Δf .

The link coupled circuit and certain modifications are of particular interest. The response of the circuit, Fig. 4, may be expressed by

$$\frac{I_2}{I_P} = \frac{j\omega M_1 \omega M_2 / \omega C_1}{Z_1 \omega^2 M_2^2 + Z_2 \omega^2 M_1^2 + Z_1 Z_2 Z_M}$$

or for convenience

$$\mu = \frac{1/Z_M}{Z^2 + 2\omega^2 M^2 Z/Z_M}$$

Its chief difference from the inductively coupled unit

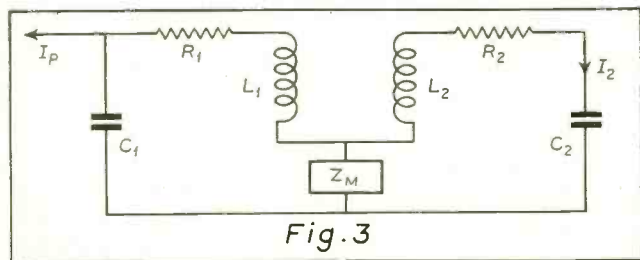

Fig. 3

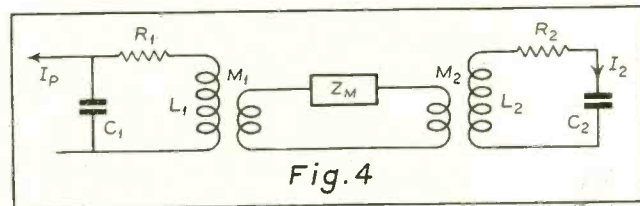

Fig. 4

is determined by the character of Z_M . If Z_M is expressed as $A + jB$, Δf_1 becomes

$$R + \frac{A\omega_0^2 M^2}{A^2 + B^2}$$

The value of R^2 as shown on the chart may be represented by

$$\frac{U}{4} = \left(R + \frac{A\omega_0^2 M^2}{A^2 + B^2} \right)^2$$

The coupling plotted linearly in terms of k in units of $\frac{U}{4}$

may have positive or negative values.

$$k = \frac{(B^2 - A^2)(\omega_0^2 M^2)^2}{[(A^2 + B^2)R + A\omega_0^2 M^2]^2}$$

Inspection shows that with extreme values of A and B the expression approaches zero. The frequency shift of the linear term is

$$\Delta f_{s1} = \frac{B\omega_0^2 M^2}{4\pi L (A^2 + B^2 + \frac{A}{R} \omega_0^2 M^2)}$$

That of the squared term is

$$\Delta f_{s2} = \frac{B\omega_0^2 M^2}{4\pi L (A^2 + B^2)}$$

This is $\frac{B}{2A}$ of the expansion of Δf_1 resulting from the term

$$\frac{A\omega_0^2 M^2}{2\pi L (A^2 + B^2)}$$

The frequency shift of the linear term is slightly less. If the mutual inductance, M , is made with a minimum of leakage reactance to avoid excessive frequency shift, expansion of Δf_1 may be accomplished as tone compensa-

(Continued on page 24)

THE MANUFACTURE OF



(Courtesy RCA Radiotron)

Illustration 1—Trimming excess screen material from side wall of a cathode-ray tube bulb. The operator removes the material with a brush while the bulb is slowly rotating.

Illustration 2—Assembling electrodes of the electrode gun. The electrodes are placed on a special jig which maintains correct alignment of parts during the assembly process. Alignment tolerance must be held within approximately four thousandths of an inch. The operator is placing the focusing electrode over the jig guide. Focusing electrodes, like other parts used in the construction of cathode-ray tubes, are precision made. The edges of the beam apertures in focusing electrodes are finished so finely that they are microscopically clean. This insures a clear beam spot on the screen.

Illustration 3—Welding the electrode gun to the stem and cathode assembly. Perfect alignment of the five electron gun apertures must be maintained to insure a clean beam spot. This assembly operation is done on a jig which is frequently checked by engineers.

Illustration 4—Checking electrode spacing. Every cathode-ray tube receives this microscopical inspection.

Illustration 5—Inserting the completed assembly of a 913 in its glass-topped metal shell. The two components are welded together by an electric current of the order of 75,000 amperes, which flows for a small fraction of a second. This welding operation forms an air-tight envelope.

CATHODE-RAY TUBES



6



5



7

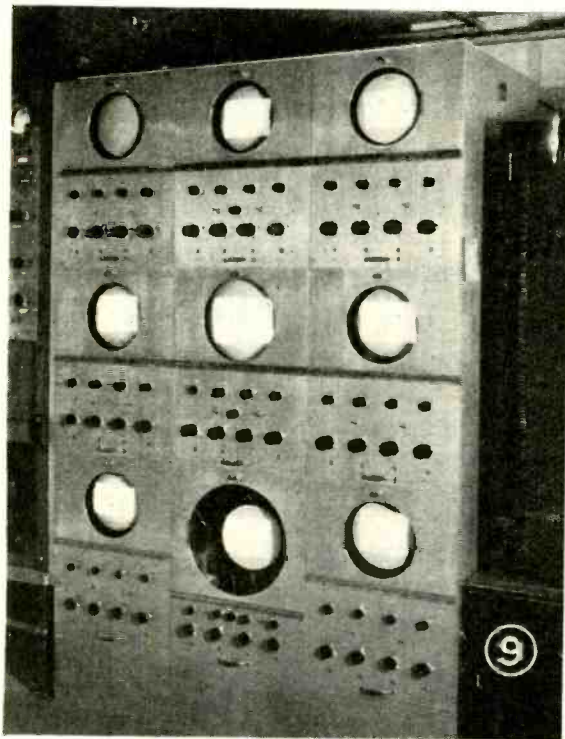

9

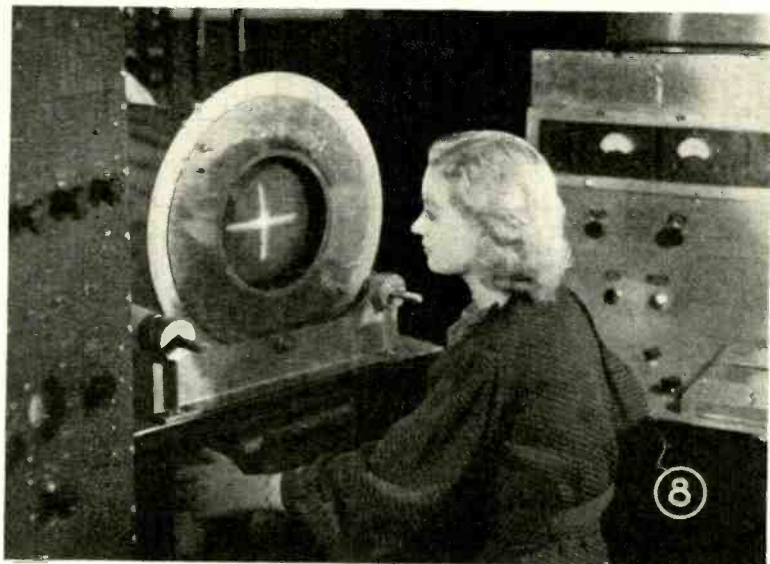

8

Illustration 6—Basing the large 9-inch cathode-ray tubes, type 903. The base is lined with a cement which has the property of setting when subjected to heat. The prepared base is carefully fitted to the tube and the assembly passed through a rotary oven to make a permanent seal. It is very important that the base be correctly aligned on the tube so that the screen pattern will be perfectly horizontal when the tube is inserted in the socket of the equipment in which it is to be used.

Illustration 7—Seasoning 913's. Each tube, before final inspection, is operated for a length of time sufficient to stabilize its characteristics.

Illustration 8—Final cathode-ray tube electrical inspection. Among the tests given at this point are: emission, deflecting-plate sensitivity, screen efficiency, all anode currents, beam focus, beam center, and gas. This picture shows the operator checking the deflection-plate relationship of a large cathode-ray tube. The testing apparatus is designed to compensate for magnetic fields which may be set up by neighboring apparatus and by the earth itself.

Illustration 9—Life test equipment for large cathode-ray tubes. Representative tubes are taken from production and operated under various conditions. Each tube is checked periodically during this extended test and its salient characteristics carefully analyzed. When the characteristics of a tube fall below the established high standards, its useful life is considered to be terminated.

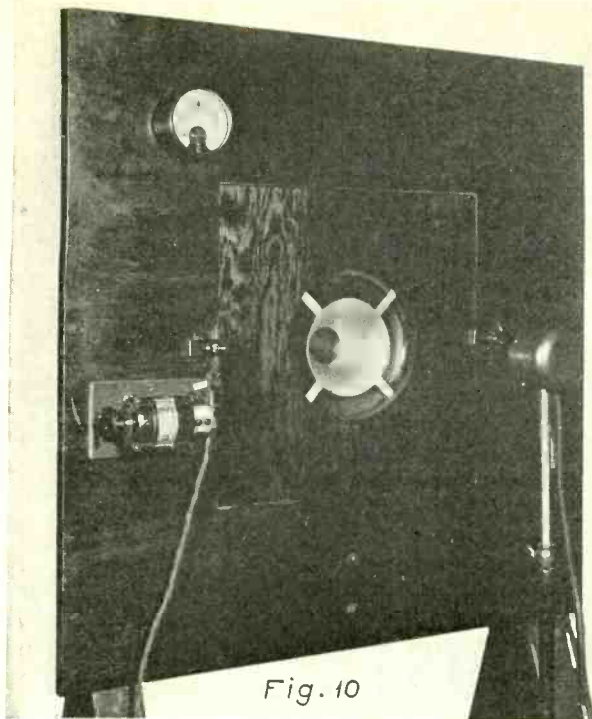

Fig. 10

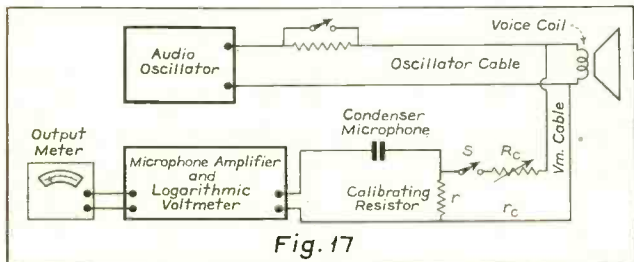

Fig. 17

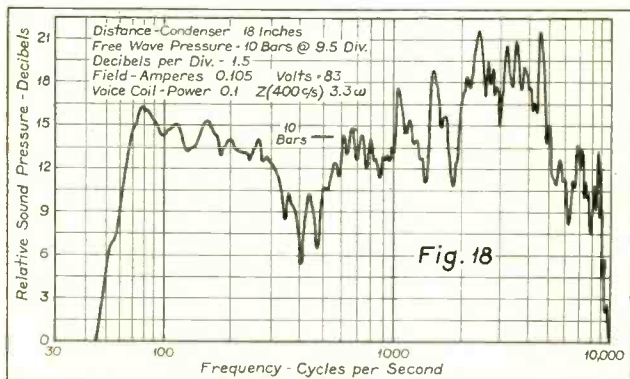

Fig. 18

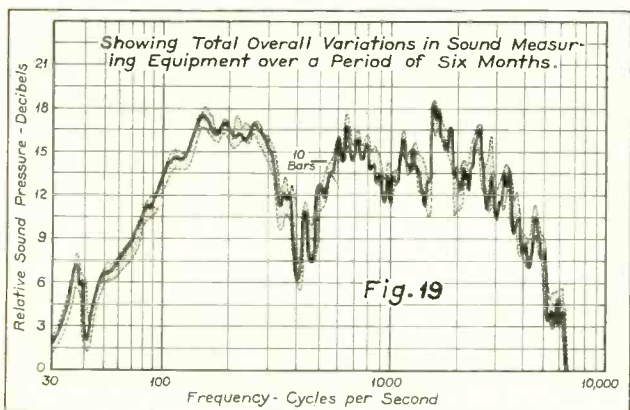

Fig. 19

then adjusted until the voltage E_R is equal to the voltage E_S . Curves of E_R and E_S are then drawn, as shown in Fig. 15. The impedance at any frequency is easily calculated from the simple relation

$$Z_s = \frac{E_s}{E_R} \times R \text{ ohms}$$

or may be readily measured by means of a suitable scale of impedance plotted logarithmically.

(c) By reference to the chart, Fig. 16, the voltage on the voice coil is set at the value necessary to produce one-tenth volt-amperes in the voice coil at frequencies in the region of its minimum impedance (the resistance R being shorted out). This chart is made in such manner that it is unnecessary to determine this voltage accurately; instead it is set in terms of position of the pen on the paper.

(d) The control switches are now adjusted to produce the circuit of Fig. 17 (the microphone polarizing voltage having been removed and the oscillator frequency having been adjusted to 500 cycles). The calibrating resistor R_C is adjusted to the value given on the chart, Fig. 16. The input to the microphone calibrating resistor r now corresponds to ten bars pressure since this is the pressure used in calculating Fig. 16. The resulting output from the amplifier is marked on the paper, using the curve drawing equipment.

(e) The switch S is now opened, polarizing voltage is applied to the microphone, and the response frequency characteristic is drawn over the range from 30 to 10000 cycles. It will be noted that constant voltage over the frequency range is applied directly to the voice coil during this operation. This is not in accordance with existing IRE methods and definitions, which do not apply to the modern high-impedance pentode or class B or beam-power amplifiers. The constant voltage method gives the response of the loudspeaker itself independently of the circuits to which it may be connected. If it is desired to know the response of a given loudspeaker when connected to any particular circuit, the only additional information necessary is the voltage-frequency characteristic which this circuit will supply to its voice coil. The determination of this characteristic is the problem of the circuit development engineer, not the loudspeaker designer. A typical response and frequency characteristic is given in Fig. 18.

The procedure outlined above in sections (c) and (d) eliminates all errors in measured response which might be introduced by errors in meter calibration or variations in amplifier gain or other faults which can be expected in vacuum tube operated devices. Referring again to section (d), it is seen that the position of the reference pressure mark (ten bars) on the paper is dependent on the calibration of the variable (decade box type) resistors R of Fig. 14 and R_C of Fig. 17, and on the voltage E_s applied to the voice coil during operation (c). Now if this voltage E_s is erroneously high or low, the reference pressure mark will appear proportionately high or low on the paper. Also, when the response curve is drawn the sound pressure at all frequencies will also be high or low by the same proportion (assuming that the loudspeaker has linear response over the small range of voltage which we are now considering). Hence, the ratio of the recorded sound pressure to the recorded reference pressure will be independent of the voltage E_s on the speaker. Further, since the ordinate scale is logarithmic, the recorded sound level above or below the recorded reference pressure level will be independent of voltage

(Continued on page 25)

REFINEMENTS IN A-C, D-C SET CONSTRUCTION

An ever-increasing number of "gadgets" are being made available to set manufacturers. Herein is described a receiver designed to take advantage of several of them.

by Myron J. Morris*

IN THIS DAY and age, the a-c, d-c receiver has become a household utility rather than a novelty. In the past, the trend has been toward smaller and cheaper sets. Today, however, the tendency is to larger sets of better quality. The purpose of this article is to set forth some of the points necessary for an acceptable a-c, d-c console receiver. In this set, all the desirable features are included from the dealer's, service man's, and customer's standpoint. The design of this receiver is such that it may be easily adapted for expert use.

Naturally a superhetrodyne circuit was decided on. The entire r-f portion was built on a separate chassis, cushioned on rubber mountings to prevent any acoustic howl and to stabilize the operation of the first detector and i-f amplifier. The 6E5 tube is also mounted on a rubber cushion to prevent tube rattle against the front of the cabinet. The mounting is so designed that the tube can easily be removed for replacement. The first detector and oscillator makes use of a 6A8-G tube with an iron-core antenna transformer. An iron-core transformer was used in this case to make up for the lack of an r-f stage; the high gain and selectivity character-

istics of this coil add to the overall gain of the receiver. A shielded oscillator coil and tuning condenser complete the first detector. The circuit of the intermediate-frequency amplifier is conventional; however, iron-core transformers were not used because the increase in gain which would be obtained was not necessary and also the increase in amplification would tend to make the stage unstable. So, for these reasons, air-core transformers were decided on. Both the input and output transformers are mounted on the r-f sub-chassis. The mechanical construction of this chassis is such that if in time it becomes necessary to service the r-f portion, by simply removing four cap nuts the whole chassis can be swung upward and the entire circuit is readily available. In laying out the chassis in this manner, complete shielding is maintained, reducing to a large extent the oscillation (birdies) and hum pickup by the first detector. In some former types of sets, servicing was a problem. All parts were crowded into as small a space as possible making trouble-shooting even more difficult. It was small wonder that many servicemen shied away from any kind of an a-c, d-c set. This difficulty is overcome by the layout of the various sections of

the set. From the pictures, it can be seen that all parts are easily reached and all voltages are located on a central lug strip.

The second detector uses a 6Q7 as a half-wave detector and a first audio amplifier. The volume control is somewhat out of its normal place on the chassis. It was removed to the rear of the set to permit short leads to the second detector and phono jack. To do this, the volume control had to be equipped with an extension shaft; by means of a small shaft coupling and a short piece of fibre rod, the extension was easily made. A small angle bracket screwed to the chassis securely mounts the control. The phono jack is a small circuit-breaking type which is mounted on the rear top side of the chassis. When a crystal pickup is used with this set, a high-fidelity phono-combination can easily be made. It will be noticed that a tapped volume control is used so as to provide tone compensation for low volume levels. A grid cap shield is used on the 6Q7 to maintain the shielding and to prevent hum pickup which is prevalent in all high-gain audio channels.

A pair of 25B6-G tubes provide
(Continued on page 21)

*American Radio Hardware Co., Inc.

Bottom and top views of a-c, d-c chassis.

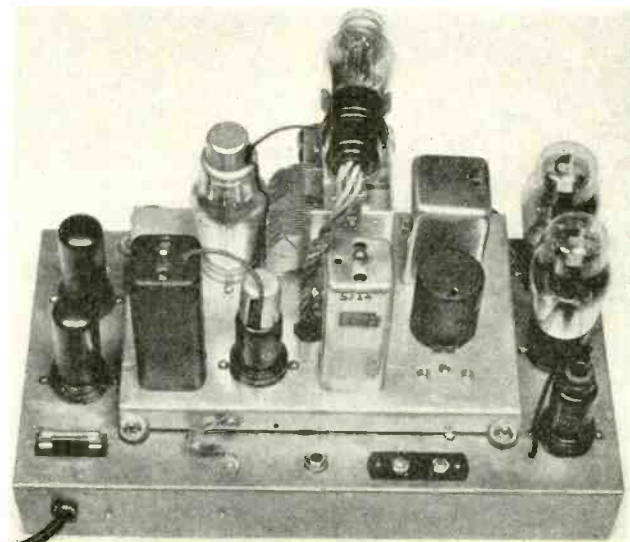
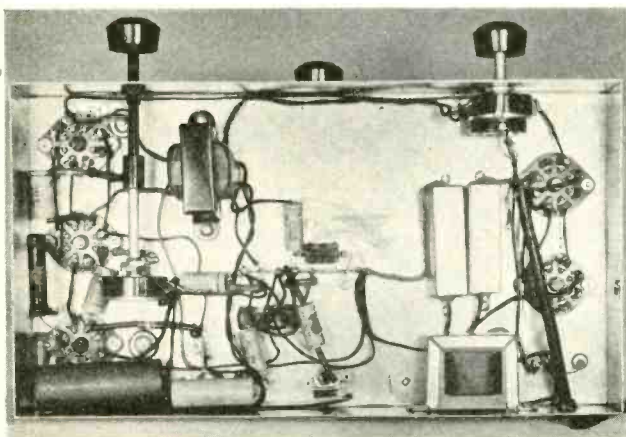

EQUIPMENT FOR RADIOTHERAPY

Rado fever is one of the latest toys of the doctors. Various types of equipment, which may be of interest to the radio industry, are described below.

by Aaron Nadell

RADIO FREQUENCIES at present used in medical practice are obtained either from vacuum tube or quenched gap oscillators, and operate into a wide variety of loads the nature of which depend upon the therapeutic results desired.

Frequencies found advantageous range from 1,000 kc to 30 mc. Current medical opinion inclines to believe that specific frequencies have no selective effect either upon body tissues or malignant micro-organisms. Proper choice of frequency in accordance with the results desired is, however, important biologically.

Applications of r-f to medical purposes can be divided, very broadly, into three general classes: means for raising the temperature of body tissues; means for exciting the "electric knife" and similar surgical instruments; means for producing ultra-violet radiation either without or within the body.

Current medical terminology distinguishes between diathermy and short-wave therapy. Diathermy is the term applied to treatment with frequencies of the order of 1,000 kc applied by direct contact of electrodes with the body of the patient. The thermal effect produced by this method depends rather largely upon the ohmic resistance of the tissues through which the current must pass. Short-wave therapy uses from 30 to 9 meters, roughly. Direct contact with the electrode is employed for some purposes, while for others the patient is placed between the plates of a condenser or in the field of an induction coil.

The primary purpose of both treatments is to raise the body temperature. Increase of body temperature is followed by several distinct reactions, all of which may be favorable to the patient under certain circumstances.

An indirect benefit results from the stimulation of blood and lymph circulatory systems. Both capillary blood vessels and small lymph passages are dilated by heat. Increased circulation may result in direct washing away of

body poisons or harmful deposits. It also brings to the heated tissues a larger number of the germ-eating white corpuscles of the blood.

Nevertheless, some types of radio fever are dangerous to some types of infections. Thus diathermy, which acts mainly upon the surface and subcutaneous tissues, may prove harmful in the case of carbuncles, driving the infection into the unheated deeper layers. Short-wave therapy, on the other hand, has been found helpful in such cases because the temperature rise is more evenly distributed in three dimensions.

A very wide variety of electrodes and of techniques is required both by reason of the number of diseases now being treated by radio-therapy, and by reason of the construction of the human body, in which the great divergence in the nature of the tissues alters heating effects according to the locality involved.

The three types of heating mechanism, conductive, inductive and electrostatic, operate differently upon different tissues, and choice among them is made by the physician. The equipment is so built that any of the three types of electrodes can be plugged in as required.

Many of the electrodes, particularly among the contact type must at times be introduced into orifices of the body for direct application to the seat of the trouble. They are, consequently, made in many different sizes and shapes. The condenser plates are made in a number of different sizes, for concentrated or diffused application of heat. To enable them to fit the contours of the part of the body to be treated, they often consist of sheets of soft metal foil, which is readily bent and shaped, thoroughly insulated in heavy layers of rubber or felt or both. The induction coil may take the form of a heavily insulated flexible cable that can be curled into a spiral and laid upon the body, or twisted into a helix about an arm or a leg.

The contact electrode is often used in association with a condenser plate, particularly for internal applications. Thus, in the treatment of sinus infec-

tions, a condenser plate the size of a large saucer may be propped in front of the patient's face at the end of a stiff cable, and a small contact electrode introduced into the nostril. Or two contact electrodes may be introduced into the orifice, or one into the orifice and a contact electrode placed upon the surface of the body nearby. Or the condenser effect may be used entirely. In some sinus treatments, to continue with that example, heavily insulated plates are bound upon the patient's forehead. Still another method in such cases is to place the patient's head between two plates—insulated against accidental contact and burns—which do not touch the patient at all.

The design of the apparatus is always such as to assist the physician in avoiding accidental burns. One precaution is to key the output by means of a foot switch, operated by the physician, which is never closed when contact electrodes are being applied or removed, but only after a firm and broad contact has been established. When a large contact electrode is applied to a rounded surface—a shoulder, for example—soft metal foil is used and shaped to press upon a relatively large area. The object here is to avoid contact at a few points only, which would result in high current density at those points and again be likely to burn the subject.

Double precautions are taken in the matter of electrode leads. They are heavily insulated to avoid accidental burns, but in use are also carefully kept away from the patient's body in order not to heat portions of his anatomy where heat might possibly stir up trouble rather than allay it.

Temperature tests are made by inserting small thermometers or thermocouples into the tissues, either during the treatment or immediately after the r-f has been switched off. Intra-muscular increases of temperature amounting to as much as 9.1 degrees F have been recorded after twenty-minute applications of 10.5 meters, with equipment nominally rated at an output of 420

watts. Intra-muscular temperatures as high as 107 degrees F and subcutaneous temperatures up to 106.9 degrees F have been recorded in this way.

The electric knife may here be considered a generic term applied to three types of surgical apparatus. The knife itself cuts flesh, and to a lesser degree, fatty tissues, by direct application of r-f at very high current densities. The desiccator, or electro-coagulator, applies a slightly broader surface at lower current densities, and sears flesh.

The desiccator is favored in the more modern type of tonsil removal, or "tonsil coagulation." In one method, an electrode is placed against the back of the patient's neck, and the desiccator is applied to the tonsil. A more modern method eliminates the contact plate at the back of the patient's neck and substitutes a two-electrode desiccator or coagulator. The principle in every case is the same; current density is high enough to sear flesh only at the point where the coagulator is applied.

The electric knife is essentially a coagulator which consists of an extremely thin, stiff wire of steel or tungsten, with correspondingly higher current density. It cuts human flesh very readily, so readily that the thin stiff wire does not even bend appreciably as it is drawn through the tissues.

A variety of the electric knife consists of a closed loop of thin, stiff wire. The loop is pressed into the flesh and then drawn through a shorter or longer distance and pulled up again. A section of tissue as much as a quarter-inch deep is removed—without bleeding and with little chance of infection—for microscopic or other examination, as, for example, in cases of suspected cancer.

In place of radiotherapy or electric knife loads, ultra-violet light generators may be plugged into the oscillator for internal or external use. One large "sun lamp" consists merely of a quartz bulb containing mercury, and a bit of argon to assist ionization. The bulb, under its reflector, is surrounded by a few turns of inductance which is energized by the oscillator. Different types of bulbs will give a wide spectrum, ranging principally from 2800 to 3100 Angstrom units, or a narrow spectrum in which the predominating frequency is close to 2500 A.u. The vapor in the latter is under lower pressure, and the bulb remains cold.

Extremely small ultra-violet generators of the latter type are available, some not much larger than the tip of a radio jack. These, firmly fastened to the end of an equally thin but well-insulated cable or catheter, which carries r-f can be introduced into the lungs and other deep-seated organs, bringing the germicidal properties of ultra-violet light

to infections not easily attacked by any other form of treatment.

Oscillators are of two general types, one using standard vacuum-tube circuits, and one using the quenched spark gap. In the latter, the electrodes are of tungsten and, to obtain relatively high energy at frequencies up to 30 mc, are ground with optical precision and spaced at less than 1 mil. The gap is not sealed, but open to forced draft which provides cooling and facilitates quenching. Three frequencies are present in the gap: the 60 cycles of the power supply; the 20000-cycle wave-train frequency, and the 30-mc tuned frequency.

The oscillating circuits are conventional, and may be described as the tuned spark or primary circuit, a tuned secondary or tank circuit, and the output or "patient" circuit.

The latter presents a special problem because of the great variety of electrodes used, and the number of ways in which each electrode may be applied. A mere change in the position of the patient, with reference to the electrodes, may detune the output circuit. A condenser, or in some models an inductance or a loose coupler, is provided, and is continually adjusted during treatment as required, adjustment being made by reference to a hot-wire ammeter, and the condenser, tuner or coupler reset for maximum reading whenever the patient shifts position with reference to the electrodes, or the electrodes themselves are changed or adjusted.

A-C, D-C SET

(Continued from page 19)

plenty of output power for faithful reproduction. Much has been said and written about phase inversion for driving a push-pull output stage from a single-ended input. In a receiver of this type, a transformer cannot be used, for the following reasons: First, cost. A transformer is necessarily more expensive than resistance coupling. Secondly, a transformer to give good fidelity requires more space than can be spared in a chassis of this size. To fill the requirements of this audio channel, a circuit is used which is not well known in this country. The inversion is accomplished in the plate circuit of one of the output tubes. The voltage divider is designed to take a portion of the signal of the same amplitude applied to the grid of the other output tube. The ratio of these two resistances will depend on the amplification of the tubes used. The blocking condenser should be of such capacity as to pass the lowest frequency desired which in this set was 50 cycles. The overall frequency re-

sponse of the audio channel is substantially flat from 50 to 7500 cycles. There is a rise of approximately 2 db at 100 cycles which compensates for the small speaker which might be used with this type of set. A permanent magnet speaker is recommended for this set. Permanent magnet speakers have reached a high degree of efficiency and are economical in operation because no field supply is necessary, thus effecting an economy in current consumption and component parts.

Wiring was considerably simplified by the use of terminal strips. These strips are used as terminal boards, tie-points, and to support resistors and condensers rather than depend on the leads to support the components. These strips are very inexpensive and add to the appearance of the wiring as well as simplifying the hookup. A fuse is included in the negative return lead. Doing this will save many rectifier tubes from overloads as well as saving the main's fuses. Another feature is the line cord anchorage. A special snap-in grommet securely grips the wire without knotting, taping, or the use of special cable clamps. This grommet prevents wear and shorting where the line cord passes through the chassis.

All the features of this set contribute toward its excellent operation. It has stood up under all tests put to it and has given very satisfactory performance over several weeks. The set has very good fidelity, selectivity, and sensitivity. The author takes this opportunity of thanking the Wholesale Radio Service Company for their contribution toward the design and construction of this receiver.

CORRECTION

SEVERAL DRAFTING errors in recent issues have come to our attention. In the February 1937 issue, Fig. 3, page 16, should have been as shown below.

In Fig. 4, page 22, of the March 1937 issue, the curve is erroneously shown with a slope of 45 degrees. It is obvious that such a characteristic would result in the absence of either compression or expansion.

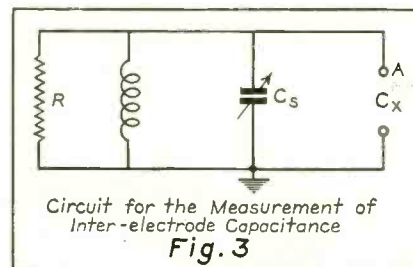

Design . . NOTES AND

THE ISOCHROMETER

THE ISOCHROMETER is an instrument which will indicate when two periods of vibration or their multiples are in unison. Isochrometric measurements described here are based on the measurement and observation of beats between two sources of vibration. While there is nothing new in this principle, the methods employed are simple and effective, fast enough for production work and in most cases accurate enough for laboratory requirements.

The equipment required consists of a Neobeam Oscilloscope and a relatively high resistance voltmeter across the 8-ohm substitute resistor load used across the "Speaker" terminals when the speaker is disconnected. The small 1000 ohm-per-volt rectifier type works very well, the 0-1 volt scale being best for close work, although the 0-5 volt range is satisfactory for most applications.

The type of input required varies with the application, a microphone being used for sound work, crystal pickup for mechanical vibration study, and direct connection to the oscilloscope for electrical inputs.

The simplest problems are those involving tuning instruments, forks, pitch pipes, audio oscillators, etc., against a standard pitch or frequency.

As a typical illustration of the application of isochrometer measurement to audible tuning, consider the calibration of the well-known tuning-fork. Usually this is done by ear, the number of beats per second between the fork and standard indicating the difference in pitch between the two units. However, it is very difficult for the ear to perceive less than two beats per second, four being about the optimum number. For this reason auxiliary standards are often used which are exactly 4 vibrations off pitch. Another weakness of the ear is its inability to tell when frequencies are close together, whether a sound is higher or lower than the standard.

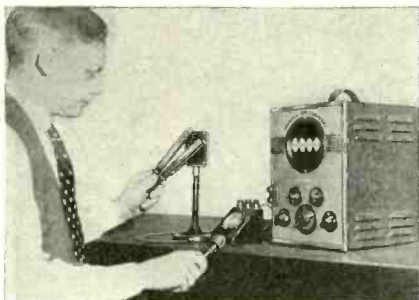

Fig. 1.

Usually a small piece of wax is placed on the ends of the forks, thus lowering the pitch, to determine what adjustments are necessary. Using the isochrometer setup as described herein, performance is thought to be better.

Holding the standard fork near the microphone as shown in Fig. 1, the sweep of the Neobeam is synchronized. The Neobeam Oscilloscope has a mechanical sweep which synchronizes with the input but does not lock with it. The "sensitivity" (input control) is adjusted to get approximately a 100 percent modulated pattern; Fig. 2. The output meter now reads about $\frac{1}{2}$ volt. If we now hold both a standard and non-standard fork near the microphone a beat is obtained equal to the difference in pitch. The interference pattern may be observed in the oscilloscope since the amplitude of the waveform is increased where the frequency patterns coincide and is diminished where they conflict, but for simplicity in production work the voltmeter indication is preferable. As the beats are reduced to about 4 per second, it is possible to note each one by a "kick" in the output voltmeter. As the beats become lower in frequency the meter needle gradually rises and falls. Ten second beats are fairly easily observed in the audio-frequency range and represent an accuracy sufficient for all practical purposes.

We now want to know whether the non-standard is high or low in frequency. With the oscilloscope synchronized with the standard fork as described above, a stationary pattern is seen. The pattern of the non-standard, not being synchronized, will drift slightly. If the frequency is low, it will drift to the left; if high it will drift to the right. The kind of pitch adjustment necessary is therefore determined instantly.

The isochrometer method of tuning may also be used quite successfully on the frequency one octave above the standard. The effect of the beats, however, becomes increasingly diminished as higher octaves are attempted.

While only tuning-forks have been discussed there has not been found any tone source or instrument that could not be compared or calibrated in a similar way. The ease of tuning by this method is especially apparent in matching frequencies of different waveform. It is often difficult for any but a highly trained ear to distinguish beats between different sound sources when the waveform of each is quite complex. The isochrometer method matches the cyclic

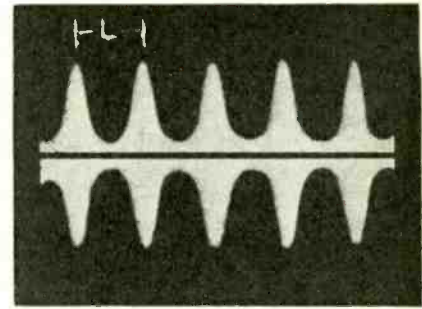

Fig. 2.

sound energies, as it were, of the vibrations under comparison and definite beats are obtained irrespective of waveform. The best results are obtained when the input to the oscilloscope from each source is approximately equal. A sustained tone is also a great help inasmuch as it is difficult to match tones of short duration.

The accuracy of the isochrometer method depends almost entirely on that of the standard. Measurements have been confined to the range from 30 to 10000 cycles which represents the maximum range of the Neobeam Oscilloscope for audio tuning purposes.

Sundt Engineering Co.

FROM SOME LETTERS ON THE TUBE TUBE NUMBERING SYSTEM

"IF I FOLLOW your argument, you believe that the RMA system has become cumbersome and meaningless. The system apparently never attempted to have such meaning as you are trying to infer to it, as, of course, the numbers have been more or less a mechanical system for referring to a certain tube type. Of course, tube numbers such as the 25AB6G are cumbersome. It is doubtful whether a system to eliminate suffixes such as "G" and "MG" would be any less difficult as this would automatically mean that duplicate numbers would have to be used for such types with a cross reference to elaborate charts to determine interchangeability. That is, provision should be made in any numbering system for additional "alteration letters" to indicate improved replacement types. Neglecting these alteration letters the maximum number of digets that can appear at present will be six. A system such as you propose does not lessen the number of figures. It is, of course, also obvious that a distinction must be made between the

COMMENT . . . Production

metal and glass tubes from the standpoint of a difference in both wholesale and retail value for the purposes of cost records even though they may not be necessary from the standpoint of the customer.

"You propose that the difficulties with the present RMA block numbering system be solved by using a different block numbering system on the basis of the principal use of each type of tube. In other words, you propose to solve the confusion of one block numbering system by introducing another block numbering system. I have seen the failure of at least four different block numbering systems on industrial as well as radio receiving tubes due to the fact that any division into five or ten identified groups in one year has always resulted in the need for additional unforeseen groups within the next two years. The only system for numbering tubes which is actually fool-proof and will not break down under any circumstances is to start numbering them from either 1 or 1000 and to go through in straight numerical order with no further identification whatever other than possibly a letter prefix common to all tubes. A study of the system of type numbers used in lamps for General Electric, Westinghouse, and Tung-Sol shows the suitability of this system. This system will reduce the number of figures involved from that under the RMA system where assignment of lots necessitates a large number of unused combinations."

*Alan C. Rockwood,
Raytheon Production Corp.*

"There are at least two strong reasons for including letters in any tube code. In the first place there are only ten figures, but there are 36 letters and figures. A two-position code using figures only gives only 110 designations, whereas a two-position code using both letters and figures gives 1332 designations.

"In addition, letters can be used as initials of words in such a way that their meaning is instantly obvious, whereas a code based on figures only is to some degree arbitrary.

"Letters alone, however, are also to some degree arbitrary, especially if any of the information to be conveyed is numerical information—plate or heater voltage, for example.

"The writer would suggest a combination code using both letters and figures. The actual number of positions

used is unimportant, and the apparent clumsiness of such an arrangement doesn't matter in the least, provided the meaning of any designation is instantly obvious. A code of this type could be so arranged that the characteristics of any tube appeared in the name of that tube, and are inherent in that name. Further, such a code could be so arranged that an engineer, needing a tube for a specific purpose, could codify his requirements in such a way that the result represented the name of the tube desired.

"If this suggestion were followed the code designations would appear grotesque, but only at first glance. For example, a tube might be called 6LPOM250, which certainly seems difficult to remember, and almost ridiculous as a name for anything. Yet, translated, it means only: 6, 6-volt heater; L, low gain; P, pentode; O, octal base; M, metal tube; 250, maximum plate voltage.

"The use of arbitrary designations would further simplify the number just given. Thus, in place of the plate voltage in figures, the same information could be given in an arbitrary letter code, each letter of the alphabet representing, say, fifty volts. The designation just cited then becomes 6LPOME—the E standing for a plate voltage of 250.

"The real question to be decided, in the opinion of the writer, is the conflict between simplicity of name and the amount of information the name ought to convey. If the name is shortened the data included become more scanty; if generous data are desired the name must be lengthened accordingly. In any case, however, the use of letter-and-number combinations results in a much shorter name for the same quantity of description."

H. G. Rolls

In connection with Mr. Rockwood's remarks about the three-digit system, we would like to point out that in one of our early editorials on the tube numbering system (*RADIO ENGINEERING*, October, 1936) we pointed out the advantages of the three-digit plan. The only requirement is that one have a reasonably good memory. Furthermore, the three-digit system—calling it three-digit simply because there probably would never be *more* than three—had the distinct advantage of absorbing, without any change whatever, many of the older tubes which are still in exist-

ence and which are still being used to some extent; such types as the 10, 45, etc., are of this classification.—*Editor.*

HIGH-FIDELITY SPEAKER

TO FULFILL the most exacting requirements for true high-fidelity sound reproduction, there has been introduced a new console cabinet loudspeaker with a substantially uniform frequency response range of from 60 to 10000 cycles.

The cabinet is of modern design, finished in black with aluminum trimming. It has been acoustically treated and scientifically coordinated with the speaker unit to give what is said to be exceptional tonal quality. The outstanding performance characteristics of the speaker make it particularly applicable for use as a high-fidelity monitoring speaker by the large broadcasting stations. It is especially fitted for use in music rooms, classes for music appreciation, hotel lobbies and wherever lifelike reproduction with the utmost fidelity is a factor of prime importance.

The console is completely enclosed and measures 33-1/3" high, 28-1/4" wide and 16-1/2" deep. The speaker unit is of the double voice coil electrodynamic type, and measures 8" by 8" and 7" in depth. The power handling capacity of the loudspeaker is 10 watts and it has a voice-coil impedance of 15 ohms. Receptacles are provided for supplying either a-c or field current supply to the unit, and also for audio input.

RCA Mfg. Co., Inc.

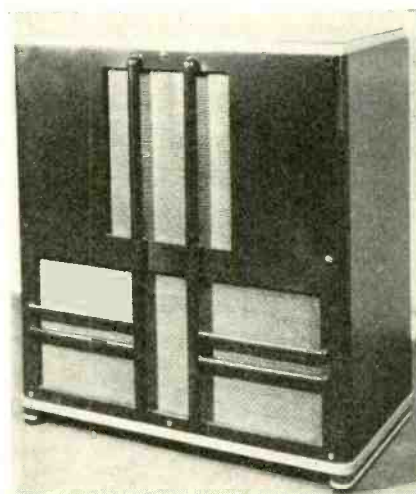

RCA high-fidelity speaker.

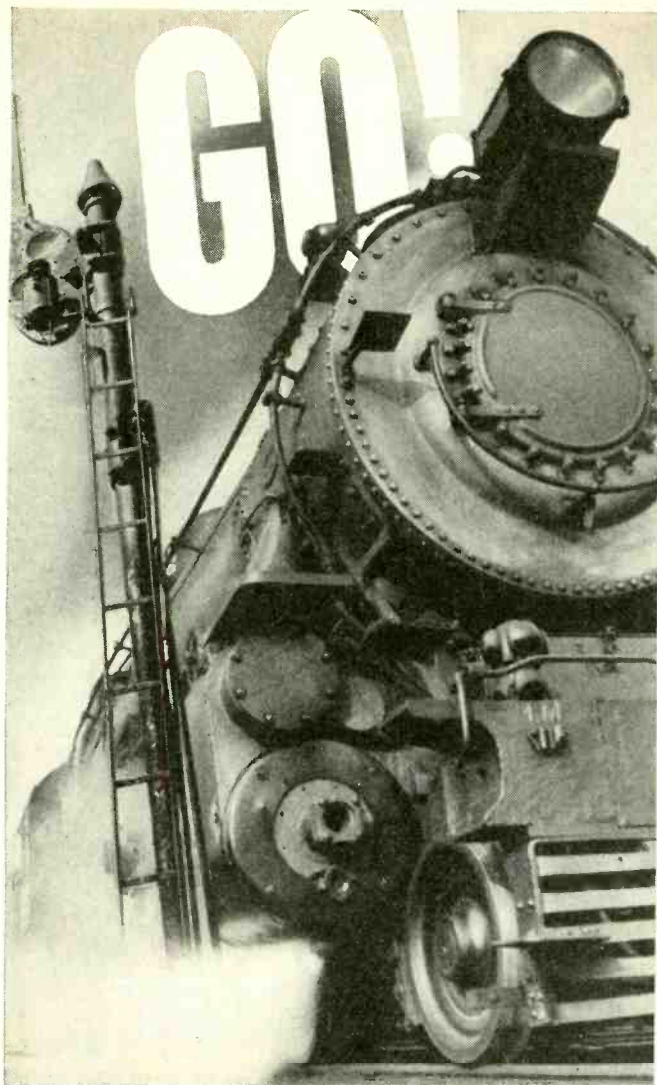

... and it **GOES**

to any customer anywhere in America. Add TOP-speed and INTELLIGENT handling. You're set for a fast-moving shipping season on stock orders, replacements and spare parts — wholesale or retail, at low economical cost. Pick-up and delivery in all cities and principal towns without extra charge. For super-speed, use Air Express. For service, simply telephone the nearest Railway Express office.

RAILWAY EXPRESS
RAILWAY AGENCY INC.

NATION-WIDE RAIL-AIR SERVICE

GRAPHICAL REPRESENTATION OF BAND-PASS CHARACTERISTICS

(Continued from page 13)

tion in the use of a variable resistance as A for a volume control.

Practically, the response of the link coupled circuit may be considered as a double-tuned circuit with near zero coupling. The variable factor is the expansion or contraction of the frequency scale with nominal variations of the coupling factors.

As a modification of the link coupled circuit, Z_M may be made a resonant circuit equivalent to Z_1 and Z_2 . Then

$$\frac{I_s}{I_p} = \frac{j\omega^2 M^2 / \omega C}{Z^2 + 2Z\omega^2 M^2}$$

Complete expansion gives terms to the third power. Graphically, the expression can be represented by a vector which follows points from a parabola to a third degree curve on planes at right angles to each other, with the line of intersection of the planes calibrated linearly in terms of frequency. However, the expression is adapted to graphical representation more directly by considering the circuit as a combination of a single-tuned circuit, and a double-tuned circuit with coupling of $2\omega_0^2 M^2$.

$$\mu = \frac{1}{R + j4\pi\Delta fL} \times \frac{1}{R^2 + 2\omega^2 M^2 - (4\pi\Delta fL)^2 + j2R(4\pi\Delta fL)}$$

The application of almost any band-pass filter may be made as some combination of the two types shown on the two charts; in fact, the single tuned circuit chart alone can be used.

To achieve certain band-pass characteristics, various combinations of r-f and i-f tuned circuits may be employed. If the individual units are to possess relatively uniform band-pass response, considerable gain is sacrificed which requires additional amplification for its restoration. Also, the selectivity factor is greatly reduced. This may be compensated for to any desired degree by the addition of tuned units. Both factors considered together naturally require an addition of tubes. This may be satisfactorily applied to the more expensive high-fidelity receivers without objection. On lower priced radio sets, fair band-pass characteristics may be attained by using tuned units of lower values of R/L , such that the r-f units compensate for the pronounced double peaks of overcoupling and low values of R/L of the i-f units.

The conception of the treatment of the band-pass characteristics of tuned units as a vector following a parabolic curve may be usefully employed in determining constants of the units. Assuming the resonance frequency known, the equivalent of only one factor is required for each tuned circuit unless the skewness is desired. In measuring quantities for determining the constants of a unit, the input should be the equivalent of the vacuum tube with which the unit will be used. With constant tube excitation or voltage generation, the relative output response as measured by a vacuum-tube voltmeter at different frequencies will determine the characteristics of the unit.

For the single-tuned circuit unit, the factor is the apparent $\frac{R}{4\pi L}$ value or the frequency difference be-

tween resonance and the frequency at which the response is $\frac{1}{2}\sqrt{2}$ of that at resonance.

A double-tuned circuit unit with greater than critical coupling may have its constants of Δf_1 and coupling, k , determined by the relative response at resonance and frequency of maximum response. If ρ is the ratio of maximum response to resonance, and Δf_M , the frequency deviation of maximum response from resonance, the coupling is

$$k = 1 + 2(\rho^2 - 1 + \rho\sqrt{\rho^2 - 1})$$

and

$$\Delta f_1 = \frac{\sqrt{2} \Delta f_M}{\sqrt{\rho^2 - 1 + \rho\sqrt{\rho^2 - 1}}} = \frac{2 \Delta f_M}{\sqrt{k - 1}}$$

A unit with less than critical coupling may give a value of k above critical if the two tuned circuits are sufficiently staggered. If the difference in frequency of the two tuned circuits is Δf_d , the increase of coupling is

$$\frac{\Delta f_d^2}{\Delta f_1^2}$$

This relationship is useful in determining the condition of alignment of a unit for which the correct coupling is known.

If the coupling is less than critical, a general expression must be employed which involves the relative response at resonance and two other frequencies, and the ratio of the frequency deviation from resonance of the two frequencies.

For routine testing purposes, specific values best adapted for the purpose may be given to two of the three quantities Q_1 , Q_2 , and n ; and a chart prepared showing values of Δf_1 and k in terms of the third. With the determination of these, other conventional quantities may be determined.

EQUIPMENT AND METHODS USED IN MEASUREMENTS OF LOUDSPEAKER RESPONSE

(Continued from page 18)

or voltmeter calibration or amplifier gain. In fact, by reference to Figs. 14, 16 and 17, it may easily be seen that the only variable (other than decade-type resistors which are normally good enough to be considered as invariable) entering into this measurement is the performance of the microphone itself. We check the performance of the microphone and the overall performance of the entire equipment from time to time by drawing a frequency response characteristic on a particular "standard" loudspeaker which is kept exclusively for this purpose. The overall variation in performance of this entire equipment including this speaker is surprisingly small, as indicated in Fig. 19. This figure is a composite characteristic made by superimposing all the characteristics drawn on this "standard" speaker over a period of six months. All of these characteristics will lie within the shaded area shown on this figure. The heavy line is a typical one of these characteristics.

(To be continued)

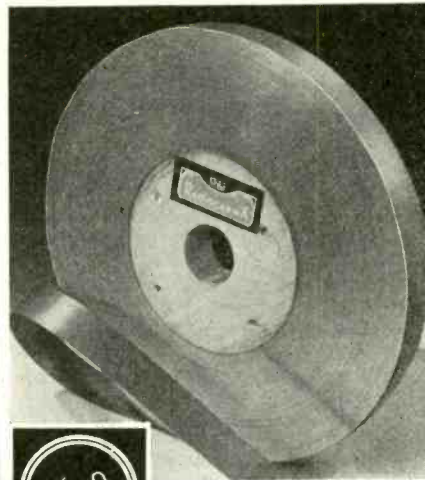

Carbonized nickel ribbon for tube plates.

All widths up to 6". Thickness from .002 to .020".

Surface of uniform maximum blackness.

Free from loose carbon, slivers, waves, seams, rough edges, oil and grease.



RADIO CARB A

Here's still another Wilbur B. Driver Radio Tube Material. And as usual, customer's specifications are rigidly observed.

WILBUR B. DRIVER CO.

formerly GILBY WIRE COMPANY
NEWARK, NEW JERSEY

THE HOTEL OF THE MONTH

Ventura Hotel
ASHLAND
KENTUCKY



ALBERT

PICK

HOTELS

You'll get more for your money at Pick Hotels. Spacious, comfortable rooms. Delicious food and real personal service. All at moderate prices.

CHICAGO, ILL. GREAT NORTHERN HOTEL
DETROIT, MICHIGAN..... TULLER HOTEL
DAYTON, OHIO..... MIAMI HOTEL
COLUMBUS, OHIO..... CHITTENDEN HOTEL
COLUMBUS, OHIO..... FORT HAYES HOTEL
TOLEDO, OHIO..... FORT MEIGS HOTEL
CINCINNATI, OHIO..... FOUNTAIN SQUARE HOTEL
CANTON, OHIO..... BELDEN HOTEL
INDIANAPOLIS, INDIANA..... ANTLERS HOTEL
ANDERSON, INDIANA..... ANDERSON HOTEL
TERRE HAUTE, INDIANA..... TERRE HAUTE HOUSE
ASHLAND, KENTUCKY..... VENTURA HOTEL
OWENSBORO, KENTUCKY..... OWENSBORO HOTEL
JACKSON, TENNESSEE..... NEW SOUTHERN HOTEL
ST. LOUIS, MO..... MARK TWAIN HOTEL
WACO, TEXAS..... RALEIGH HOTEL



THE WORD PICK SHOULD ALWAYS REMIND YOU OF ALBERT PICK HOTELS



RMA DIRECTORS MEETING; JUNE CONVENTION PLANS

Final arrangements for the thirteenth annual RMA Convention and membership meetings at Chicago, June 8-9, will be made at a meeting of the RMA Board of Directors in April. President Leslie F. Muter of the Association has tentatively planned the Board meeting April 16 at The Homestead, Hot Springs, Virginia.

Several immediate industry problems and future sales promotion plans also will be considered at the April meeting of the RMA directorate. It is expected there will be early developments in connection with the pending trade practice rules for set manufacturers, still in negotiation with the Federal Trade Commission.

A big industry banquet of the RMA in the Grand Ball Room of the Stevens Hotel, Wednesday evening, June 9, is a projected highlight of the RMA Convention. A. S. Wells of Chicago again will head the banquet and convention arrangements committee of RMA. An unusually large attendance is expected because the RMA convention banquet is scheduled to immediately precede the opening on June 10 of the radio parts manufacturers' National Trade Show at the Stevens. The parts show is an assured sell-out. Booth reservations now total 130 and a capacity show is certain. During the show the fifth annual convention of the Institute of Radio Service Men will be held and there will be an unusual industry radio conclave in connection with the show and the preceding RMA convention. An industry golf tournament is scheduled June 10.

FEBRUARY EXCISE TAXES

Collections during February 1937 of the 5 percent tax on radio and phonograph apparatus by the U. S. Bureau of Internal Revenue were \$464,853.41, an increase of 10 percent over the February 1936 collections of \$423,673.38.

Excise taxes collected on mechanical refrigerators last February were \$786,430.94 compared with \$572,594.87 in February 1936.

DECEMBER, 1936, LABOR INDICES

"Seasonal slackening of activities" caused a decrease of 3.7 percent in radio industry employment during December 1936, according to the December report of the U. S. Bureau of Labor Statistics. Of the eighty-nine manufacturing industries included in the monthly government survey, fifty-two showed more employees in December than in the preceding month and sixty reported larger payrolls, not including gifts or bonus payments.

Despite the December decrease of 3.7 percent in radio factory employment, it was 6.6 percent greater than the industry employment in December 1935. The December 1936 radio employment index figure, based on the new revised index of the 1933 census, was 202.7 percent compared with the November index figure of 210.6.

Radio factory payrolls last December declined only 1.2 percent from November 1936, and were 21.9 percent greater than

payrolls in December 1935. The December index figure on payrolls was 167.5 compared with 169.4 in November 1936.

Average weekly earnings last December of radio factory employees were reported at \$21.67, an increase of 2.7 percent over November 1936 earnings, and 14.3 percent greater than December 1935 weekly earnings. The December 1936 national average of weekly earnings of all manufacturing industries was \$24.83, while the national average of all durable goods manufacturing establishments was \$27.94. The all-manufacturing figure was 3.5 over the November average and 10.2 percent over the December 1935 average, while the figures on all durable goods manufacturers was 2.8 percent above November 1936 and 12.3 percent higher than December 1935.

Average hours worked per week in radio factories last December were 38.9 hours, an increase of .9 percent over average hours in November 1936, and 10.1 percent higher than December 1935. The national average work hours of all manufacturing industries during December was 41.1 hours, an increase of 1.3 percent over November 1936 and 6.0 percent over December 1935, while the national average of all durable goods manufacturing industries was 42.8 hours, an increase of 6.7 percent over December 1935.

Average hourly earnings last December of radio factory employees were 55.7 cents, an increase of one cent or 1.8 percent over hourly earnings during the preceding month of November, and were 3.9 percent higher than average hourly earnings in the industry in December 1935. The national average hourly earnings of all manufacturing industries was 59.4 cents, an increase of 2.6 percent over November 1936 and 4.0 percent over December 1935. The national average hourly earnings of all durable goods manufacturers reporting was 64.4 cents, an increase of 2.8 percent over November 1936 and 4.8 percent above December 1935.

RADIO INTERESTS WELL TREATED BY STATE LEGISLATURES; ANTI-RADIO BILLS KILLED

Radio interests generally have fared well in their treatment by forty-three state legislatures which began sessions last January. In three months of an unusual legislative period in the states, no important anti-radio bill has been passed and considerable hostile legislation has been killed. Although many states have adopted fair trade practice laws, state merchandising provisions similar to the federal Robinson-Patman Act, and state tax and licensing laws applying alike to all industry, the RMA Legislative Committee is gratified over the radio record to date. Many bills in the interest of radio also have been enacted by a number of states. A large number of state legislatures have already adjourned and others soon will be closing their sessions. With an unusually heavy volume of radio legislation, constant action has been taken by the RMA in protecting the interest of the industry.

"Finis" was written on the Idaho bill to prohibit automobile radio when the Idaho Legislature adjourned March 6. The Idaho bill died in committee, killed by the House of Representatives despite its previous passage by the Idaho Senate and following the opposition of RMA, broadcasting and automotive interests.

Also killed was a similar bill against automobile radio in the Washington State Legislature. It was introduced following the Idaho bill but likewise died, without any favorable action or consideration, with the adjournment of the Washington Legislature.

West Virginia was added to the states requiring police permits for operation of short wave, but not standard, receiving sets in automobiles. The RMA and the industry in the interest of law enforcement, does not oppose restriction to police of automobile short wave sets. The West Virginia legislature also authorized establishment of a state police radio system.

In the Arizona legislature a bill to prohibit short-wave radio sets in automobiles failed of enactment.

Radio equipment of state police is growing rapidly. There has been such legislation recently in Iowa, Minnesota, Pennsylvania, North Carolina and Virginia.

Radio interference also is an increasing subject of state legislative action. Bills are pending in the Iowa, Nebraska, New Hampshire and Oklahoma legislatures to require filtering equipment or otherwise regulate interference with reception.

In Massachusetts there has been introduced and pending a bill for a state board to license radio installation and service, and in Missouri a bill has been introduced for state regulation of electrical equipment installation, including radio.

The bill in Arizona proposing an exemption from personal property tax of one automobile, one radio, and one refrigerator failed of enactment.

Also killed or not enacted has been much broadcasting legislation, including measures designed to establish state boards of censorship and special taxes on broadcast stations.

NEW PATMAN BILL

Representative Patman of Texas, co-author of the Robinson-Patman law, has introduced in Congress his new bill to prohibit manufacturers in interstate commerce from selling at retail in certain cases. The new bill would declare it an unfair method of competition under the Federal Trade Commission Act for manufacturers to sell at retail to consumers when the effect would be to substantially lessen competition, prevent competition or tend to create a monopoly.

The new Patman bill is before the House committee on Interstate Commerce and is involved in various administration plans under consideration in connection with trade practices and agitation for substantial amendment of the original Robinson-Patman law.

RADIO INTERFERENCE STUDIES

Radio interference problems were considered further at a meeting on February 17 of the radio-electrical coordination committee of RMA, NEMA and the Edison Electric Institute at the offices of the latter. Dr. W. R. G. Baker, chairman of the RMA Engineering Division, presided, and special reports were received on preventing radio interference caused by electrical-medical equipment and also coordination of international work on prevention of radio interference.

NEW RECORD IN 1936 EXPORTS

Peak export trade in radio was attained in 1936. Total exports of radio apparatus for the year were \$28,284,251, against total exports of \$25,454,188 in 1935, the previous high record for the American industry.

The principal 1936 export increase was in parts, although increases were recorded also in sets, tubes, speakers and transmitting apparatus.

As compiled by RMA from reports of the Bureau of Foreign and Domestic Commerce, U. S. Department of Commerce, the exports for 1936 with comparative 1935 figures follow:

JANUARY EXPORTS INCREASE 27 PER CENT

Export trade of the industry had an auspicious start in January 1937 with an increase of 27 percent over January 1936, according to the January report of the U. S. Bureau of Foreign and Domestic Commerce. Total radio exports in January 1937 were \$2,584,207, compared with \$2,039,522 in January 1936.

Receiving set exports last January numbered 59,457 valued at \$1,584,538, compared with 46,951 sets exported in January 1936 valued at \$1,243,672.

Tube exports last January numbered 653,520 units valued at \$280,597, compared with January 1936 exports of 491,354 tubes valued at \$227,822.

Exports of receiving set components in January 1937 were \$522,775, compared with \$315,064 in January 1936.

There were 26,001 loudspeakers valued at \$58,600 exported in January 1937, compared with 12,382 speakers valued at \$29,801 in January 1936, and exports last January of transmitting apparatus totaled \$137,697 compared with \$223,163 in January 1936.

RADIO INTERFERENCE COMMITTEE

Numerous measures to reduce radio interference, with special study of diathermy machines were developed at another meeting, March 31, at New York, of the Joint Coordination Committee on Radio Reception of the Edison Electric Institute, RMA and NEMA. L. C. F. Horle, consulting engineer in charge of several engineering projects for RMA, presided at the meeting.

RMA TUBE COMMITTEE

Further tube numbering and standardization problems were considered at a meeting in New York, March 6, of the RMA Committee on Vacuum Tubes of which Roger M. Wise of Emporium, Pa., is chairman. Details will be received soon by RMA Tube Division members.

AUSTRALIAN TUBE QUOTA REDUCED

The Australian Government has reduced the import quota on radio tubes for the period from January 1 to June 30, 1937, according to an official report to the U. S. Bureau of Foreign and Domestic Com-

merce. Under the new quota, Australian importers can import from the United States during the first six months of 1937 a supply of radio tubes equivalent to 25 percent of the quantity imported from the United States during the year ended April 30, 1936. This quota, for the previous six months' period, was 50 percent of the quantity imported from the United States during the year ended April 30, 1936.

CANADIAN SALES IN JANUARY

According to information from the Canadian RMA, receiving set sales in January 1937 of Canadian manufacturers numbered 9,401 with a list value of \$917,936 compared with January 1936 sales of 10,475 sets valued at \$1,020,725.

Of the Canadian sales last January, 7,615 sets were of a-c type valued at \$789,457; 1,667 were battery sets valued at \$121,567, and 119 automobile receivers valued at \$6,912.

Canadian inventories on January 31 were 32,421 sets, including 24,135 a-c, 7,383 battery, and 903 automobile sets.

Projected Canadian production from February 1 to April 30 totaled 41,560 sets, including 25,644 a-c, 8,782 battery and 7,134 automobile sets.

FRENCH RADIO SHOW

The fourteenth annual radio show of France will be held by the associated-electrical industries May 14-30 at the Neoparnasse Palais, Paris. The French exhibition is open to all French or foreign radio manufacturers, dealers and importers.

CANADIAN SALES IN 1936

Sales of Canadian manufacturers in 1936 totaled 242,456 sets valued at \$21,861,128, according to reports of the Canadian RMA. In 1935 the Canadian sales were 190,248 receivers valued at \$18,062,853.

Of the Canadian sales in 1936 there were 168,353 A.C. sets valued at \$16,818,821; 61,127 battery sets valued at \$4,268,137, and 12,976 automobile sets valued at \$774,170. This compares with 1935 Canadian sales of 137,742 A.C. sets valued at \$14,157,084; 39,073 battery sets valued at \$3,034,221, and 13,433 automobile sets valued at \$871,548.

In December 1936 the Canadian sales reported were 26,904 valued at \$2,426,079, and Canadian inventories on December 31 were 39,017 sets, including 31,619 A.C. sets; 7,190 battery sets, and 208 automobile sets.

Production projected in Canada for the first quarter ending March 31 next was 26,093 sets, including 17,452 of the A.C. type; 5,416 battery sets, and 3,225 automobile set chassis.

INVITES RMA TO BUCHAREST RADIO CONFERENCE

From Secretary Hull of the State Department, an invitation has been received by RMA to participate in the forthcoming conference at Bucharest, Roumania, of the International Radio Consulting Committee (CCIR). This will be held May 21 to June 8. Preliminary work has been done by many American committees representing all radio communications interests and the Federal Communications Commission has named official government representatives.

CALLITE LEADS!

5 YEARS AGO . . .

Callite originated
and developed
KULGRID "C"

TODAY . . .
KULGRID "C"
Tungsten Welds
—the acknowledged
lead-in leader!

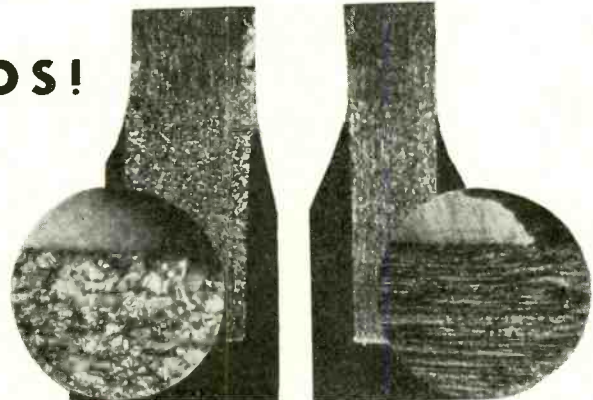

FIG. 1

FIG. 2

Kulgrid "C" is rapidly replacing ordinary copper strand because it eliminates rejections and reduces production costs.

Note the difference between Fig. 1 and Fig. 2. Considerable crystallization of the Tungsten is apparent in the weld using ordinary copper strand (Fig. 1). Excessive oxidation of the copper takes place under the processing temperatures. The resulting oxide flakes off and deposits in the tube press, causing stem leakage. Frequent-

ly, oxidation progresses to a point where the strand becomes brittle and actually falls at or prior to the basing operation.

Kulgrid "C" Strand, however, has none of these objectionable features. Note that in Fig. 2, practically no crystallization of the Tungsten takes place. Kulgrid "C" does not oxidize. It is flexible and does not become brittle. It welds more readily to Tungsten than ordinary copper strand and forms a strong joint.

Accept no inferior substitutes

CALLITE PRODUCTS DIVISION

EISLER ELECTRIC CORPORATION

542 - 39th STREET

UNION CITY, N. J.

NEWS OF THE INDUSTRY

NEWARK WIRE CLOTH APPOINTS NEW PITTSBURGH REPRESENTATIVE

The Newark Wire Cloth Company, Newark, New Jersey, manufacturers of woven wire screens and wire cloth products, announce the appointment of the J. K. Porter Company, Union Trust Bldg., Pittsburgh, Pa., as their agents to cover the Western Pennsylvania territory.

— RE —

GERBER APPOINTED CLAROSTAT REPRESENTATIVE

The appointment of Harry Gerber of 49 Portland St., Boston, Mass., as Clarostat sales representative for the New England territory, is announced by Clarostat Mfg. Co., Inc., Brooklyn, N. Y., effective April 1, 1937.

— RE —

ARCTURUS ISSUES WALL CHART

The Arcturus Radio Tube Company, Newark, N. J., has issued a new wall chart of tube characteristics. 137 types with all their rated values are listed, special tube application data are given and basing connections for all tubes are illustrated.

— RE —

G-E ANNOUNCES VACATION PLAN

A new vacation plan for the hourly rated employees of the General Electric Company was announced recently by President Gerard Swope. Under this new plan all employees with one year or more continuous service will get a vacation with pay this year.

The statement by Mr. Swope follows: "Employees who have one or more years of continuous service may be granted one week's vacation with pay, and those employees who have 10 or more years of continuous service may be granted two weeks' vacation with pay."

— RE —

NEW CATALOG ISSUED BY CINAUDAGRAPH

Cinaudagraph Corporation of Stamford, Conn., has issued a sixteen-page two-color catalog describing their new line of Magic Magnet speakers. This catalog gives a complete description of each speaker, from the small six-inch model to the eighteen-inch size, all of which employ Nipermag permanent magnets. Three new air column sound projectors are listed, as well as baffles for all models. This catalog, No. 237, and price list will be mailed upon request.

— RE —

VAN DUSEN ADVANCED BY N. U.

R. H. Van Dusen who has been holding the post of Office Manager at New York headquarters of National Union Radio Corporation, has been advanced to the position of Assistant Sales Manager according to information received from R. M. Coburn, Sales Manager of the company.

Mr. Van Dusen assumes his new position well fortified with a broad background of sales work in the radio field. Former connection involved executive work in the radio tube industry as well as in radio broadcasting.

JOINT MEETING OF THE I. R. E. AND THE AMERICAN SECTION OF THE I. S. R. U.

The annual joint meeting of the Institute of Radio Engineers and the American Section of the International Scientific Radio Union will be held in Washington, D. C., on April 30, 1937. This all-day meeting is an important feature of the week which attracts to Washington every year an increasingly large number of scientists and scientific societies. Papers on the more fundamental and scientific aspects of radio will be presented. There will be two sessions at the building of the National Academy of Sciences, 2101 Constitution Avenue, Washington, D. C., beginning at 10 a.m. and 2 p.m. Papers will be limited to fifteen minutes each to allow time for discussion.

— RE —

BRUSH MOVES TO OWN BUILDING

On April 1 The Brush Development Company, Cleveland, Ohio, moved to its own building at 3311 Perkins Avenue.

The growth of this Cleveland company which has made its name and products known throughout the world has more than kept pace with the growth of the electronic industry. It has enlarged its facilities from 1,000 square feet in 1932 to its present four-story building, and increased the number of its employees accordingly.

The manufacture and use of Rochelle salt crystal elements products of The Brush Development Company, and the effectiveness of commercial devices based on the piezo-electric principle is largely responsible for its rapid growth.

— RE —

SYNTHANE APPOINTS BORDEN

The Synthane Corporation of Oaks, Pennsylvania, manufacturers of laminated bakelite, announce the appointment of William H. Borden as their Detroit representative. Mr. Borden, until his appointment, represented the company in Pittsburgh. His offices in Detroit are located at 7310 Woodward Avenue.

— RE —

WEBSTER-CHICAGO APPOINTMENTS

Webster-Chicago have just announced the appointment of M. F. Klicpera, formerly of Operadio as Western Sales Manager with headquarters in Chicago and covering field operations from the Mississippi west. Mr. Klicpera brings to the Webster-Chicago organization the wealth of many years' practical as well as theoretical experience in sound, culminating from an association with radio dating back to 1908.

G. J. Irving, formerly of Operadio, has been placed in charge of the Sales Promotion Division, making his headquarters at the Chicago office. Mr. Irving has had many years experience in sales promotion work and actual contact with all kinds of "sound" problems. His appointment creates a new division at Webster-Chicago, with the purpose of providing an increasing amount of dealer sales helps as well as promotion assistance for all kinds of dealer activities.

RAILWAY EXPRESS PAMPHLETS

Of interest to all users and prospective users of Railway Express facilities are two pamphlets recently issued. These are entitled "How To Profit With Air Express" and "Railway Express Solves My Collection Problems."

Copies of either or both of these pamphlets may be obtained from the Railway Express Agency, 230 Park Avenue, New York, N. Y.

— RE —

SOLAR CATALOGS

Two catalogs have been issued by the Solar Manufacturing Corp., 599-601 Broadway New York, N. Y. The first covers the complete Solar line of fixed—mica, paper, wet and dry electrolytic—condensers. The other catalog is of replacement type condensers. Copies of these catalogs may be obtained by addressing the manufacturer.

— RE —

ALADDIN ISSUES CATALOG SUPPLEMENT

A supplement to bulletin 536, issued several months ago, has been published by the Aladdin Radio Industries, Inc., 466 West Superior Street, Chicago, Ill. The supplement, which covers products made available since bulletin 536 was issued, may be obtained from the company at the address given.

— RE —

LIGHT-SENSITIVE CELLS

A bulletin on this subject has been received from the General Electric Co., Schenectady, N. Y. This publication defines many terms used in photometry, gives complete technical data on G-E cells, and describes typical applications.

— RE —

ELECTRONICS INSTITUTE

During the 1937 University of Michigan Summer Session an Electronics Institute, consisting of a special lecture and conference program in electronics will be held at Ann Arbor, under the joint auspices of the General Electric Company, the Westinghouse Electric and Manufacturing Company, and the Bell Telephone Laboratories.

The Institute lectures will be given by Dr. Saul Dushman and Dr. Levi Tonks of the General Electric Research Laboratories, Mr. H. E. Mendenhall and Mr. F. B. Llewellyn of the Bell Telephone Laboratories, Dr. Joseph Slepian and Dr. R. C. Mason of the Westinghouse Research Laboratories, Professor L. B. Loeb of the University of California, and Professor W. G. Dow of the University of Michigan.

The lecture program will consist of two independent four-weeks lecture sequences, dealing respectively with high-vacuum (June 28 to July 24) and gaseous-conduction (July 26 to Aug. 20) electronic principles. In parallel problem laboratory and conference courses the lecture material will be worked into illustrative engineering problems, and teaching methods will be demonstrated and discussed. Opportunities for informal conferences will be provided.

RADIO ENGINEERING

See Radio's Latest Developments

at the

BIGGEST RADIO PARTS SHOW EVER HELD!

130 Booths, Filling the HUGE EXHIBITION HALL

At the **STEVENS HOTEL**



*Every Conceivable Kind of Apparatus for the Service Man,
the Amateur, and the Public Address Man*

CONDUCTED BY

**RADIO PARTS MANUFACTURERS
NATIONAL TRADE SHOW**

and Endorsed by

RADIO MANUFACTURERS ASSOCIATION and THE SALES MANAGERS CLUB

NEW PRODUCTS

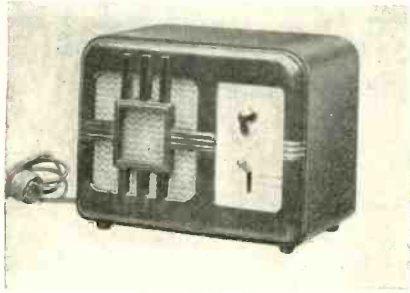

WEBSTER-CHICAGO COMMUNICATING SYSTEM

Webster-Chicago has just announced a new inter-office communicating system, offered in two types.

Type OC-2 is a system that is designed for operation between two points only. Type OCM is a multiple system that is designed to accommodate up to ten stations. A feature of the multiple system is that a number of simultaneous conversations can be carried on at the same time. Selection of station is made by the station selector dial and then the "talk-listen" switch is used in the customary manner.

The equipment is furnished in attractive, highly polished wood case with ebony finish. It is said that Webster-Chicago engineers have devoted a great deal of time to these inter-office communication systems, to insure adequate sensitivity and reproduction qualities.

— RE —

HALLDORSON VARI-VOLT TRANSFORMER

The Halldorsen Company has announced a new transformer which the service man can use at his bench for adjusting his line voltage for any requirement. Besides permitting adjustments in line voltage it will also supply the various ranges of voltages needed for testing radio sets. The Halldorsen vari-volt transformer will supply voltages from 0-256 volts in two-volt steps or from 0-128 volts in one-volt steps. Power output 250 watts maximum. Complete information can be obtained from the Halldorsen Company, 4500 Ravenswood Avenue, Chicago, Illinois.



RAYTHEON ANNOUNCES NEW TUBES

The Raytheon Production Corporation announces three new tubes. The first is an improved type tuning indicator which is interchangeable with the old 6G5. The new indicator has been given the number 6G5-6H5 and is said to afford better and more uniform illumination with both high and low voltage supplies than did its predecessor. The most noticeable improvement in the 6G5-6H5 is that it maintains constant current throughout its normal life and has no tendency to run away.

The second tube is 6W5G and is a type of rectifier designed primarily for service in automobile sets. It is interchangeable with type 6X5 and 6X5G, where higher output is desired.

The third new tube 6C8G is a twin triode amplifier designed primarily for use in phase inverter circuits. Both triodes have been designed to match each other closely, making it possible to build an inexpensive high quality push-pull audio-output system.

— RE —

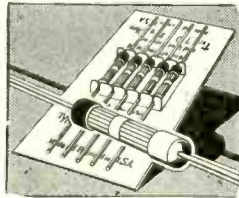

CENTRALAB INTRODUCES RESISTOR

Centralab, Inc., 900 E. Keefe Avenue, Milwaukee, Wis., have announced their type 710 resistor, a completely insulated end-lead type, conservatively rated at one-half watt. The resistors, which are R.M.A. color coded, are made in values from 100 ohms to 10 megohms.

— RE —

AUDIO OSCILLATOR

Development of a new type electronic audio oscillator which can be used as a driver source for constant modulation of air beacon transmission beams, bridge analysis or other applications where approximately 35 milliwatts of pure sine wave a-f may be used, has been announced by the Triumph Mfg. Co., 4017 W. Lake St., Chicago. The instrument was particularly designed for the U. S. Bureau of Air Commerce, a division of the Department of Commerce. The oscillator is compensated for drift due to humidity or temperature variation and is provided with 500 and 5,000 ohm output terminals. Size of control deck 5"x9", depth overall 8". Weight 6½ lbs. For operation on 60 cycle, 110 to 220 volt a-c supply.

— RE —

PANEL INSTRUMENTS

A line of low-priced panel instruments with bridge type construction and soft iron pole-pieces has been announced by the Simpson Electric Company, 5216 Kinsie Street, Chicago. This type of construction, states the Simpson organization, has only been available in instruments selling at considerably higher prices. Increased initial accuracy and lasting accuracy over a period of years are the advantages claimed for this construction.

DU MONT TWO-INCH CATHODE-RAY TUBE

A two-inch cathode-ray tube 24-XH has recently been developed by Allen B. Du Mont Laboratories, Inc.

This tube is of the high-vacuum type with four electrostatic deflection plates, two common, mounted in a glass envelope having a full two-inch fluorescent screen. It is 7½ inch overall in length and a large octal base is used. The heater voltage a-c or d-c is 6.3 volts. From 300 to 600 volts may be used on the second anode. The 24-XH is a practical tube for all routine operations where economy and compactness is essential without sacrificing screen area. Full information may be obtained from Allen B. Du Mont Laboratories, Inc., Upper Montclair, New Jersey.

— RE —

LOW-LOSS PLASTIC

A new phenolic molding compound with what is said to be an extremely low power factor has recently been developed by General Plastics, Inc., North Tonawanda, N. Y. For use on high-frequency radio and electrical equipment, this new material—known as Durez 1601—has a power factor (A.S.T.M.) of 0.34%. It also has excellent molding qualities which permit its use for a variety of applications such as X-ray machines, diathermy apparatus, high-frequency measuring and research equipment, short-wave radio parts, etc.

— RE —

PAGING SYSTEM

The Operadio Model 111 Paging System is suitable for factories, hotels, public buildings, theatre dressing rooms and other similar places. The system is supplied complete with contact type crystal microphone mounted on a stand; a special amplifier with its tubes which mounts on the wall at some convenient place near the microphone; a foot switch for use when talking; and a complement of permanent magnet dynamic speakers in attractive steel wall cabinets. Speakers are connected in parallel through a two wire system. Microphone and speaker connections to the amplifier are most simple and require no engineering on the part of the installer. The basic Model 111 Amplifier Paging System comes with four speakers, but additional speakers may be added to this basic system at slight additional cost.

Specifications and further details may be had by writing Operadio Manufacturing Company, St. Charles, Illinois for Catalog 10-A.

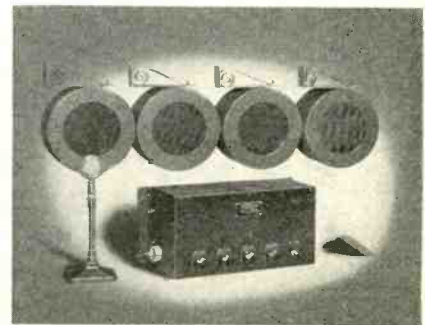

Write for your
**FREE
COPY**
of the
**"CREI
TESTED
PLAN"**

Just off the
press! New 48-
page booklet
for professional
radiomen with
a desire to suc-
ceed in Radio.

If You Are One of the **69%**

"... CREI Training Will Improve
Your Present Position" ...

A recent survey discloses that despite the late depression, 69% of CREI graduates now have IMPROVED positions, and the average salary has increased 37.4%. TECHNICAL TRAINING will not only help YOU acquire the ability to succeed, but is necessary to keep pace with the many new developments in the industry. Take definite steps to plan your future in Radio by writing to—

Capitol Radio Engineering Institute

DEPT. RE-4

WASHINGTON, D. C.
14th and Park Rd., N.W.

NEW YORK CITY
29 Broadway

HOTEL LENOX



If you paid many times our rates you couldn't enjoy finer service, more comfortable rooms, more delicious food than are obtainable at The Lenox.

RATES

Single \$1.50 to \$3.00
Double \$2.50 to \$5.00
Special 2 Rooms and Bath
3 persons \$5.00; 4 persons \$6.00

Send for free official AAA road map and folder containing handy map of downtown Buffalo.

Clarence A. Miner, Pres.
140 North St., Near Delaware

BUFFALO, N. Y.

The Walton Hotel PHILADELPHIA

... where a hearty welcome awaits you always. Here you will find quiet, comfortable rooms, courteous service and excellent food.

350 ROOMS WITH BATH

GARAGE FACILITIES ... RATES BEGIN AT \$2.50

BROAD STREET AT LOCUST

LOWER COSTS

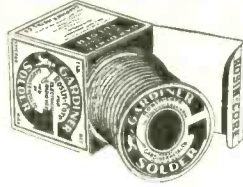

are made possible through the use of Gardiner Rosin-Core Solder. Its uniform high quality permits experienced workers to do faster work and inexperienced help to do better, neater work. It saves both time and material.

Made in various alloys and in gauges as fine as 1/32 of an inch. Because of modern production methods Gardiner Solder costs less than even ordinary kinds.

We also make bar and solid wire solders, and dipping and casting metals.

Eastern Sales Office and Warehouse:

DAVID M. KASSON & CO.
264 Canal St., New York

In 1, 5 and 20-lb. spools



4819 S. CAMPBELL AVE., CHICAGO, ILL.

WAXES

COMPOUNDS

VARNISHES

For Insulation of Condensers

Transformers, coils, power packs, pot heads, sockets, wiring devices, wet and dry batteries, etc. Also WAX SATURATORS for braided wire and tape WAXES for radio parts. Compounds made to your own specifications if you prefer.

ZOPHAR MILLS, INC.

FOUNDED 1846

120—26th Street, Brooklyn, N. Y.

Laminations

for Audio and Power Transformers. Standard stocks in a wide range of sizes. Write for dimensions and price sheets.

Dies ... Tools ... Metal Stampings

• 35 years experience manufacturing all types of magnets

• Suppliers of ALNICO MAGNETS

Specialized methods ... Prompt service

THOMAS & SKINNER STEEL PRODUCTS CO.

1113 East 23rd Street

Indianapolis, Ind.

INDEX TO ADVERTISERS

A
Acme Elec. & Mfg. Co., The..... 32

B
Bakelite Corp. Second Cover
Barber, Alfred W..... 32
Bliley Electric Co..... 32

C
Callite Products Co..... 27
Capitol Radio Engineering Inst..... 31
Crowley Co., Inc., H. L..... Third Cover
Curtis Condenser Corp..... 32

D
Driver Co., Wilbur B..... 25

G
Gardiner Metal Co..... 31
General Plastics, Inc..... 1
Guthman & Co., Inc., E. L..... 32

M
Mallory & Co., Inc., P. R..... 6

P
Paramount Paper Tube Co..... 32

R
Railway Express Agency, Inc..... 24

S
Scientific Radio Service..... 32
Swedish Iron & Steel Corp.
Fourth Cover

T
Taylor Fibre Co..... 32
Thomas & Skinner Steel Prod. Co.. 31

U
United Transformer Corp..... 3

Y
Yaxley Mfg. Division..... 6

Z
Zophar Mills, Inc..... 31

GUTHMAN *Coils*

Guthman coils and trimmer condensers are dependable! There's one to fit every job! Send for samples & quotations Today! Edwin I. Guthman and Co., Inc. 400 S. Peoria St. Chicago

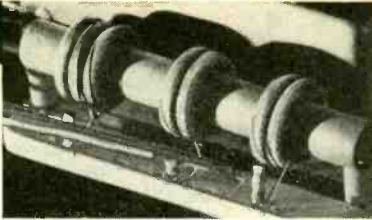

ALFRED W. BARBER

Consulting Engineer

35-33 172nd Street

Flushing, L. I.

**BLILEY
QUARTZ
CRYSTALS**

For general and special radio frequency applications between 20Kcs and 25Mcs. Write for Bulletin G-9
BLILEY ELECTRIC CO.
ERIE, PA.

PARAMOUNT PAPER TUBE CO.

MANUFACTURERS OF SPIRAL WRAPPED TUBING FOR THE ELECTRICAL INDUSTRY
SQUARE - RECTANGULAR - ROUND
2035 WEST CHARLESTON STREET

Chicago, Illinois

ACME Transformers
For radio, television and special applications.

THE ACME ELECTRIC AND MANUFACTURING CO.
1444 HAMILTON AVENUE • • • • CLEVELAND, OHIO

Curtis *Electrolytic*
CONDENSERS
Made to your specifications.
CURTIS CONDENSER CORP., CLEVELAND, O.

TAYLOR **VULCANIZED FIBRE**
PHENOL FIBRE
TAYLOR INSULATION
TAYLOR FIBRE CO., Norristown, Pa.

"THE CRYSTAL SPECIALISTS SINCE 1925"
PIEZO-ELECTRIC CRYSTALS
GUARANTEED Accurate to BETTER than .01%
SCIENTIFIC RADIO SERVICE
Send for **FREE Booklet and Price List!**
UNIVERSITY PARK - - - - HYATTSVILLE, MD.

THE Group Subscription Plan for RADIO ENGINEERING enables a group of engineers or department heads to subscribe at one-half the usual yearly rate.

The regular individual rate is \$2.00 a year. In groups of 4 or more, the subscription rate is \$1.00 a year. (In foreign countries, \$2.00.)

The engineering departments of hundreds of manufacturers in the radio and allied industries have used this Group Plan for years, in renewing their subscriptions to RADIO ENGINEERING.

Each subscriber should print his name and address clearly and state his occupation—whether an executive, engineer, department head, plant superintendent, or foreman, etc.

Remember this Group Plan when *Your* Subscription Expires

(Radio Engineering)

Bryan Davis Publishing Co., Inc.
19 East 47th Street
New York, N. Y.

AHEAD OF THE TIMES

Specify



PATENTED **CROLITE** PROCESS

CONDENSERS

Phenomenal
Performance Record
Eliminate Returns and
Servicing Trouble

MAGICORES

Outstanding Performance
Attained in
New Household Sets



CERAMICS

Molded ceramics of real low loss materials. New possibilities. Why not consider them?

LIQUID CROLITE SUPER QUARTZ

A liquid for impregnating and covering purposes with losses lower than fused quartz.

Write for Technical Data

Condensers:

Magicores:

Resistors:

Ceramics:

HENRY L. CROWLEY CO., Inc.

1 CENTRAL AVE., WEST ORANGE, N. J.

EXPORT DEPARTMENT
116 BROAD ST., N. Y. C.

SVEA METAL

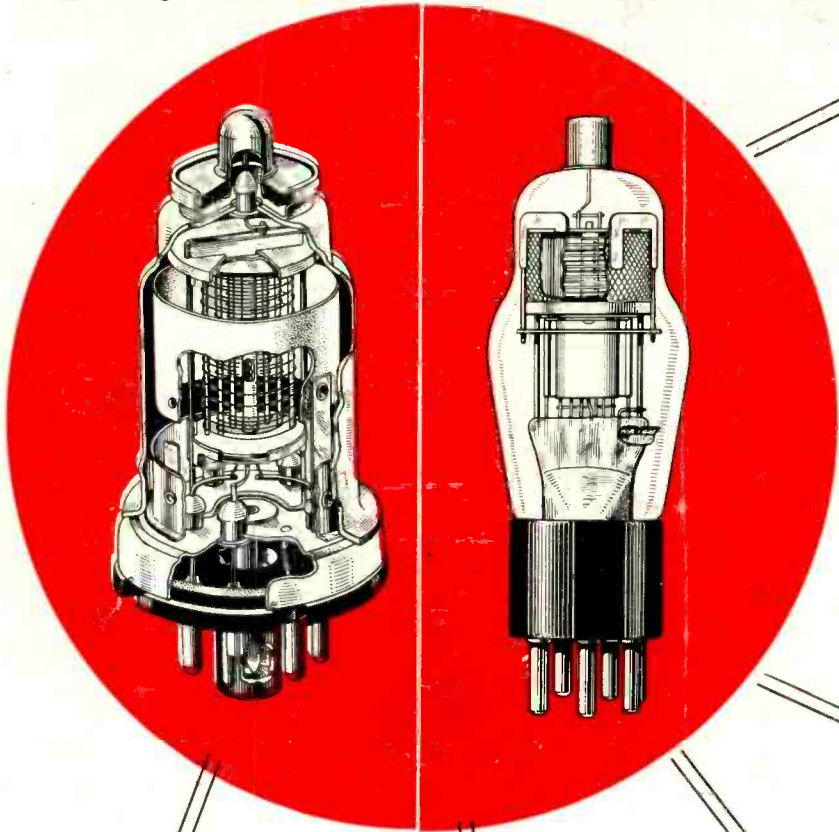

*The Product with
a Background of
300 Years of Skill
and Craftsmanship*

*All of the Advan-
tages of Higher
Priced Metals
for Bright and
Oxidized Tube Parts*

*P u r e
U n i f o r m
E c o n o m i c a l
R e l i a b l e*

*A Safe and
Sure Solution
to Quality
and Cost*

*None of the
Disadvantages
of Cheaper
M e t a l s*

Send for
Data Sheets
and Bulletin
"SVEA-ONICS"

- LOWER IN LONG-RUN COST THAN CHEAPER METALS
- BETTER IN LONG-RUN QUALITY THAN COSTLIER METALS

Swedish Iron &

17 Battery Place



Steel Corporation

New York City

For more than a quarter of a century suppliers of high grade metals to the foremost electrical equipment manufacturers